



# 液压传动/回转装置

HYDRAULIC TRANSMISSION / SLEWING DEVICES



宁波川甬液压传动设备有限公司

NINGBO CHUANYONG

Hydraulic Transmission Equipment Co., Ltd.

CFH系列液压传动/回转装置

CFK系列液压传动/回转装置

CHUAN YONG HYDRAULIC

# 企业介绍

宁波川甬液压传动设备有限公司是一家集科研开发、设计制造、营销服务和进出口贸易为一体的高科技企业。公司位于美丽的海滨城市—宁波。著名的杭州湾大桥、宁波栎社机场和深水良港北仑港，为我们提供了便捷的交通条件，并将我们与大都市上海接轨。

公司技术实力雄厚，创新研发设计能力强。汇集了一大批致力于液压传动的专业工程师，所有产品的开发都采CAD、CAM、CAE技术，主要零件由进口加工中心，数控机床加工。并与国内的科研院所建立了长期友好的合作关系，成立了静液压驱动工程技术中心。公司拥有先进的计算机自动控制的热处理车间，先进的CNC加工中心，数控磨齿机、数控插齿机、数控滚齿机、数控车床、及各类磨床、铣床、拉床、卧车、立车等加工设备，并配备先进的三坐标检测仪、多功能扭矩试验台、全数字超声波探伤仪、材料分析光谱仪、进口齿轮测量中心等完整的检测手段。

经营产品包含低速大扭矩液压马达、液压回转装置、液压传动装置、工业行星减速机、液压卷扬机、液压绞车、履带底盘总成、履带车轮行走马达、液压回转马达、各种液压油泵，齿轮泵等。产品广泛用于移动和工业领域，如工程建设、起重运输、地质勘探、船舶、铁路、石油、煤矿、农林机械、特种车辆及轻工注塑、重型冶金机械等各类静液压驱动领域中。

我们的经营理念根植于企业家精神和创新思维，面向未来，川甬液压积极发挥人才、团队力量和核心技术优势，以增强社会责任感为使命、以提升企业整体价值，秉承“追求卓越、创造完美”的企业经营方针，以创新的理念追求更高的发展目标，一如既往的向客户提供优质的产品和满意的服务。

## BRIEF INTRODUCTION

Ningbo Chuanyong hydraulic Transmission equipment Co., Ltd. is a collection of scientific research and development, design and manufacture, marketing services and import and export trade as one of the high-tech enterprises. The company is located in Ningbo, a beautiful seaside city. The famous Hangzhou Bay Bridge, Ningbo Oak Society Airport and Deepwater Port Beilun Port provide us with convenient traffic conditions and connect us with the metropolis Shanghai.

The company has strong technical strength and strong ability of innovative R & D design. A large number of professional engineers dedicated to hydraulic transmission are gathered. All the products are developed by CAD,CAM,CAE technology, and the main parts are machined by imported machining center and CNC machine tool. A long-term friendly cooperative relationship has been established with domestic scientific research institutes, and a hydrostatic drive engineering technology center has been established. The company has advanced computer-automatic control heat treatment workshop, advanced CNC machining center, CNC gear grinder, CNC gear shaper, CNC gear roller, CNC lathe, and all kinds of grinder, milling machine, broaching machine, sleeping car, vertical car and other processing equipment, and equipped with advanced three-coordinate detector, multifunctional torque test bench, all-digital ultrasonic flaw detector, material analysis spectrometer, Imported gear measuring center and other complete testing means.

The products include low speed and high torque hydraulic motor, hydraulic rotary device, hydraulic transmission device, industrial planet reducer, hydraulic hoist, hydraulic winch, track chassis assembly, crawler wheel walking motor, hydraulic rotary motor, various hydraulic pumps, gear pumps and so on. Products are widely used in mobile and industrial fields, such as engineering construction, lifting transportation, geological exploration, ships, railways, oil, coal mines, agricultural and forestry machinery, special vehicles and light industrial injection molding, heavy metallurgical machinery and other hydrostatic driving fields.

Our business philosophy is rooted in entrepreneurship and innovative thinking, facing the future, Chuanyong hydraulic actively play talent, team strength and core technical advantages, to enhance the sense of social responsibility as the mission, in order to enhance the overall value of the enterprise, with the "pursuit of excellence, create perfection" business policy, with the concept of innovation to pursue higher development goals, as always, to provide customers with quality products and satisfactory services.

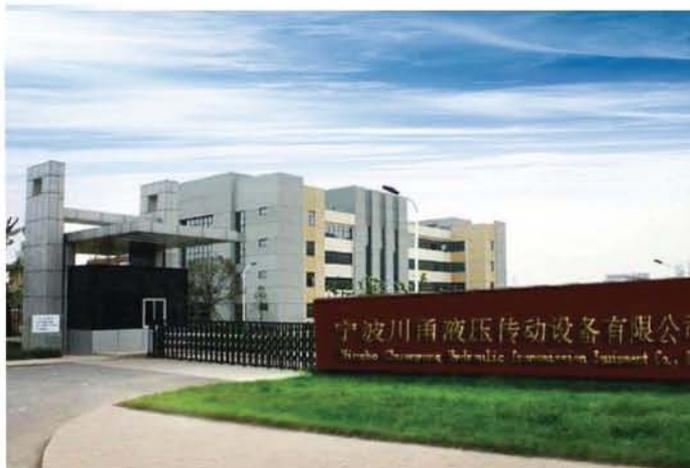

## ※ CFH液压传动装置

02-16

型号说明	01
参数说明	01
选型举例	01
选型说明	02
CFH2.5 液压传动装置	03
CFH3.1 液压传动装置	04
CFH3.2 液压传动装置	05
CFH4 液压传动装置	06
CFH5 液压传动装置	07
CFH6 液压传动装置	08
CFH7 液压传动装置	09
CFH9 液压传动装置	10
CFH2.53 液压传动装置	11
CFH34 液压传动装置	12
CFH45 液压传动装置	13
CFH56 液压传动装置	14
CFH67 液压传动装置	15
CFH79 液压传动装置	16

## ※ CFX液压传动装置

17-32

型号说明	17
参数说明	17
选型举例	17
选型说明	18
CFX2.5 液压传动装置	19
CFX3 液压传动装置	20
CFX4 液压传动装置	21
CFX5 液压传动装置	22
CFX6 液压传动装置	23
CFX7 液压传动装置	24
CFX9 液压传动装置	25
CFX2.53 液压传动装置	26
CFX34 液压传动装置	27
CFX45 液压传动装置	28
CFX56 液压传动装置	29
CFX67 液压传动装置	30
CFX79 液压传动装置	31
CFX912 液压传动装置	32

## ※ 使用与保养

33

## ※ 其他产品

34

## CFH 液压传动装置 CFH Hydraulic Transmission Devices

### ◆型号说明 / Description of Model

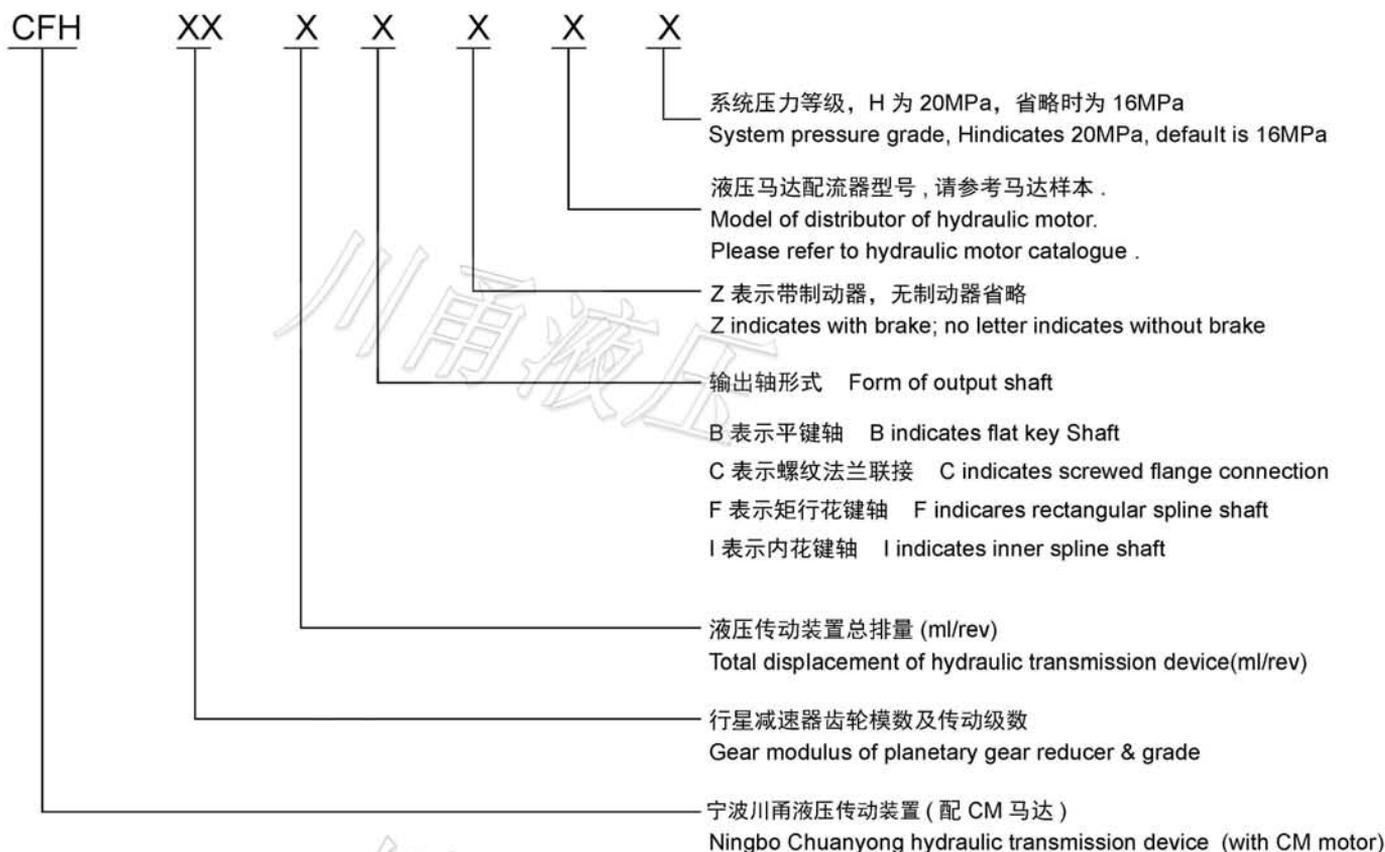

### ◆参数说明 / Description on Parameters

- 总排量为液压马达排量乘以减速传动比。  
The total displacement is calculated by multiplying hydraulic motor displacement with reduction transmission ratio.
- 额定扭矩是在系统压力为 16MPa 或 20MPa 时, 考虑传动效率后的实际输出扭矩。  
Rated torque is the actual output torque taking transmission efficiency into account when system pressure is 16MPa or 20MPa.
- 传动效率包括液压马达的机械效率和行星减速器机械效率。  
Transmission efficiency includes the mechanical efficiency of hydraulic motor and the mechanical efficiency of planetary reducer.

### ◆选型举例 / Example of Model Selection

CFH3 1000CD3 1 H 表示该液压传动装置采用单级行星减速器传动, 齿轮箱模数为 3, 总排量为 1000ml/rev, 输出轴采用螺纹联接, 液压马达配流器 D31, 额定压力等级为 20MPa。

CFH3 1000CD31 H means the hydraulic transmission device adopts single-grade planetary reducer transmission with modulus of gearbox being 3 and total displacement of 1000ml/rev; the output shaft adopts screwed connection. Hydraulic motor distributor is D31 and the rated pressure grade is 20MPa.

## ◆选型说明 /Description on Selection of Model

- (1)、CFH 液压传动装置允许在高压下工作。
- (2)、壳体允许最高压力为 0.8MPa，如有特殊要求，请与厂家联系。
- (3)、液压油：建议使用高质量、防泡沫、抗氧化的矿基液压油，理想工作油温 30℃ ~50℃，允许油温 -20℃ ~80℃，当油温低于 10℃时，必须用低凝液压油。液压油的粘度为 40~60 厘拖，允许为 5~300 厘拖。
- (4)、液压油过滤精度推荐为 25 μ m，或更高过滤精度。
- (5)、液压传动装置均可双向旋转，具体转向见附图。如用户要求与图示转向相反，请在订货时注明。
- (6)、泄油管定位： CFH 传动装置允许任何方向安装，为保证马达内各运动副的润滑，要求在工作之前将马达内充满液压油，泄油口位置的选择必须保证运转中壳体充满液压油。
- (7)、配流器的选择：各种液压传动装置可以根据不同工况要求选用各种规格的配流器，选择配流器的原则按使用压力、转速、流量、联接方式和所集成阀组要求来考虑；配流器安装：配流器进出油口方向允许按外形安装联接位置以 72 度为间隔旋转，但当松开螺钉旋转时，要当心不能损坏平面 O 形圈的密封功能。

- (1)、CFH hydraulic transmission device can work under high pressure.
- (2)、The max permissible pressure of the housing is 0.8MPa. If you have any special requirements, please contact the manufacturer.
- (3)、Hydraulic oil: recommend using high quality, anti-foaming and anti-oxidation mineral hydraulic oil. The ideal working oil temperature is 30°C to 50°C and the permissible oil temperature is between -20 °C to 80 °C When oil temperature is lower than 10°C . Low-freezing hydraulic oil must be used. The viscosity of hydraulic oil is between 40-60 CST centistokes and the permissible viscosity is 5-300 CST centistokes.
- (4)、The recommended hydraulic oil filtering precision is 25 μ m or higher;
- (5)、The hydraulic transmission device can rotate in both directions; please see the details in the attached charts. If users require the equipment to rotate in opposite direction, please make notes when you place orders.
- (6)、Positioning of oil drain: CFH transmission device allows to be installed in any direction . To ensure the lubrication of all kinematic pair, it's required to fill hydraulic oil into the motor before Working. The selection of position of oil drain port must be able to ensure that the housing is full of hydraulic oil when it operates;
- (7)、Selection of distributor: All sorts of hydraulic transmission device can select to use the distributors of various specifications according to the requirements of different working conditions The principle for selection of distributor: to select distributor according to the using pressure, rotation speed, flow, connecting method and the requirements of the integrated valve group; installation of distributor: the direction of oil inlet and outlet of distributors allows to rotate with interval of 72° around the external installation and connection location. However, when the distributor is rotated while the bolt is released, be careful not to damage the seal function of plane O-ring.

# CFH系列液压传动/回转装置

## CFH2.5 液压传动装置 CFH2.5 Hydraulic Transmission Devices

### ◆无制动器 / Without brake

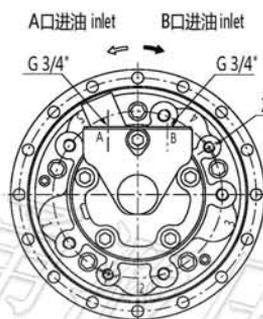
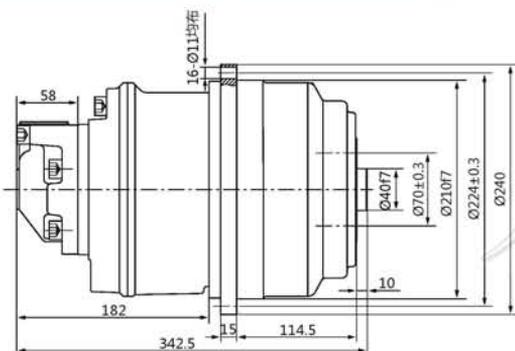

液压原理图  
Hydraulic schematic diagram

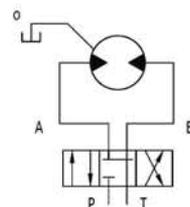

### ◆带制动器 (内置式) / With brake and internal installation

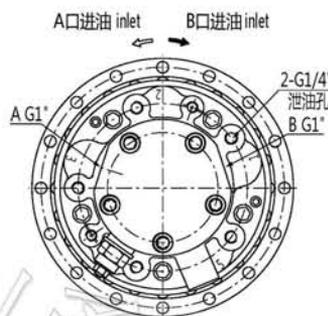
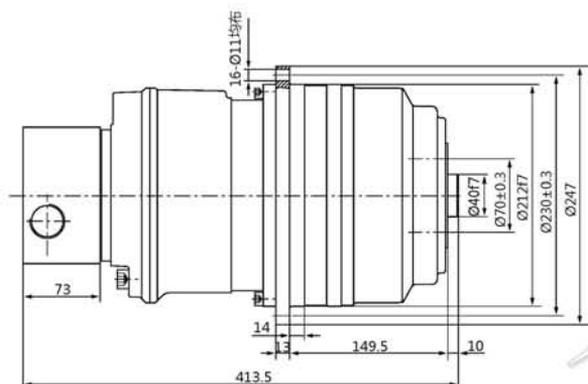

液压原理图  
Hydraulic schematic diagram

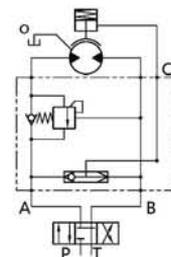

### ◆输出轴尺寸 / Shaft dimensions

B型平键输出 Cylindrical B

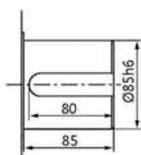

C型螺纹法兰输出 Threaded flange C

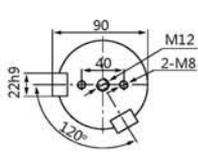

F型矩形花键输出 Rectangle splined F

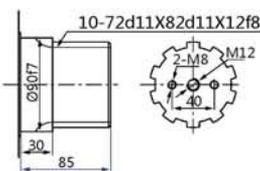
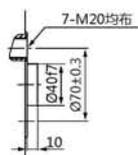

I型内花键输出 Rectangle internal spline I

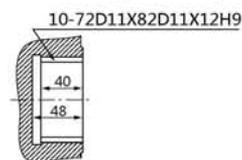

型号 Model	总排量 (ml/r) Total displacement	额定扭矩 (N.m) Rated torque	转速范围 Speed	总效率 Total efficiency	液压马达型号 Hydraulic motor	行星减速器型号 Poanetary gearbox	制动器型号 Brake
		20MPa					
CFH2.5-550	575	1630	0-100	0.88-0.9	CM05-110	C2.5-5	CZ2.5
CFH2.5-650	645	1826	0-100	0.88-0.9	CM05-130	C2.5-5	CZ2.5
CFH2.5-750	755	2136	0-100	0.88-0.9	CM05-150	C2.5-5	CZ2.5
CFH2.5-850	830	2350	0-100	0.88-0.9	CM05-170	C2.5-5	CZ2.5
CFH2.5-950	955	2706	0-100	0.88-0.9	CM05-200	C2.5-5	CZ2.5
CFH2.5-1050	1050.5	2976	0-100	0.88-0.9	CM05-200	C2.5-5.5	CZ2.5

注：外形联结尺寸及输出轴有特殊要求，请与我们联系 / Note: Please contact us if there are any requirements from customer

# CFH系列液压传动/回转装置

## CFH3.1 液压传动装置

## CFH3.1 Hydraulic Transmission Devices

### ◆无制动器 / Without brake

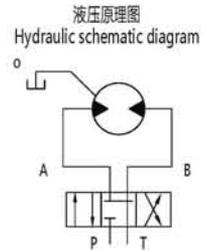
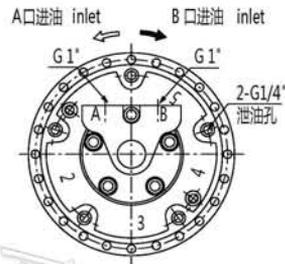
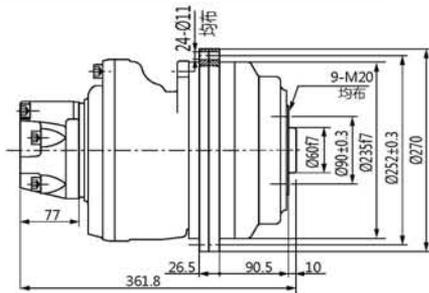

### ◆带制动器 (外置式) / With brake and external installation

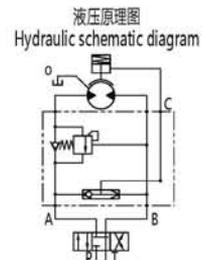
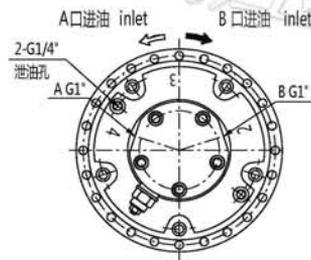
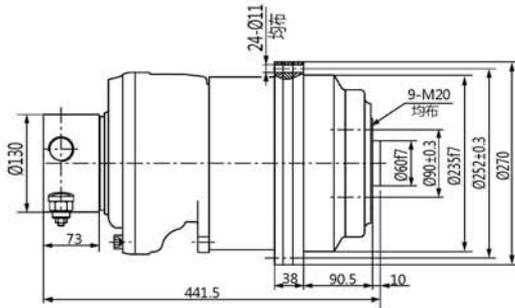

### ◆带制动器 (内置式) / With brake and internal installation

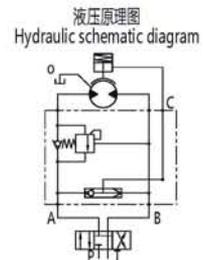
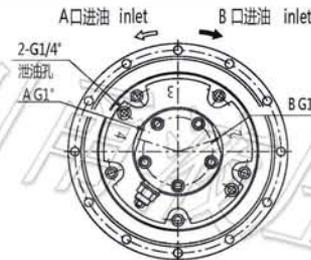
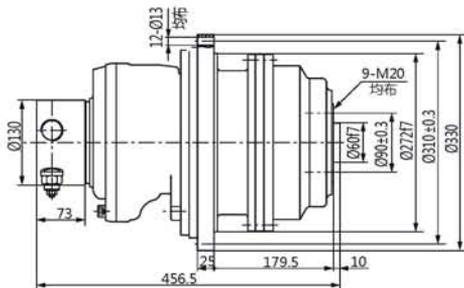

### ◆输出轴尺寸 / Shaft dimensions

B型平键输出 Cylindrical B

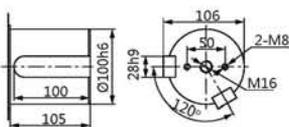

C型螺纹法兰输出 Threaded flange C

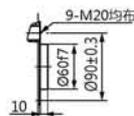

F型矩形花键输出 Rectangle splined F

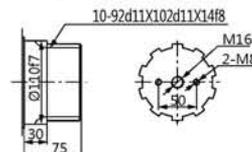

I型内花键输出 Rectangle internal spline I

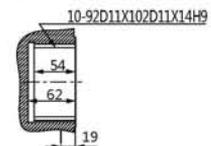

型号 Model	总排量 (ml/r) Total displacement	额定扭矩 (N.m) Rated torque	转速范围 Speed	总效率 Total efficiency	液压马达型号 Hydraulic motor	行星减速器型号 Poanetary gearbox	制动器型号 Brake
		20MPa					
CFH3-1250	1215	3382	0-90	0.88-0.9	CM1-250	C3-5	CZ3
CFH3-1450	1450	4022	0-90	0.88-0.9	CM1-300	C3-5	CZ3
CFH3-1600	1570	4361	0-90	0.88-0.9	CM1-320	C3-5	CZ3

注：外形联结尺寸及输出轴有特殊要求，请与我们联系 / Note: Please contact us if there are any requirements from customer

# CFH系列液压传动/回转装置

## CFH3.2 液压传动装置 CFH3.2 Hydraulic Transmission Devices

### ◆无制动器 / Without brake

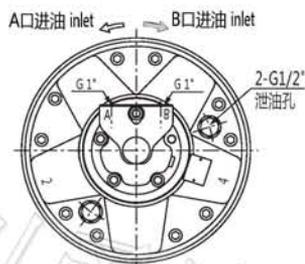
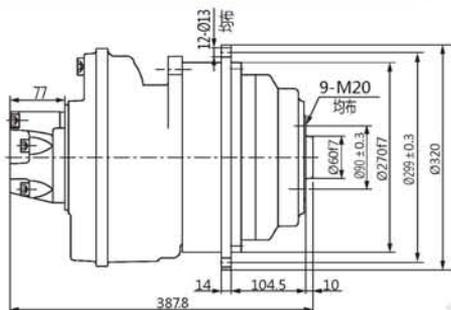

液压原理图  
Hydraulic schematic diagram

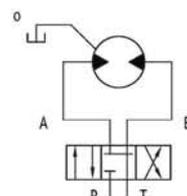

### ◆带制动器 (外置式) / With brake and external installation

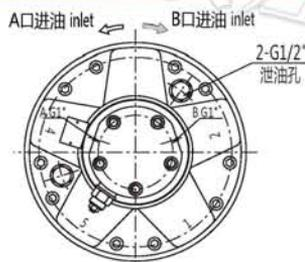
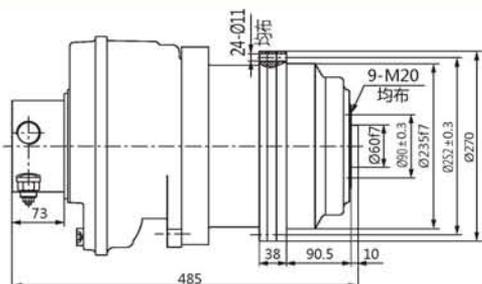

液压原理图  
Hydraulic schematic diagram

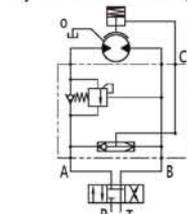

### ◆带制动器 (内置式) / With brake and internal installation

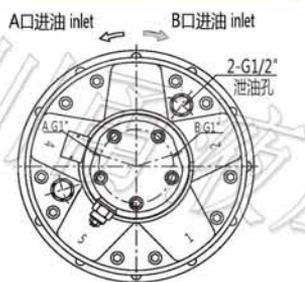
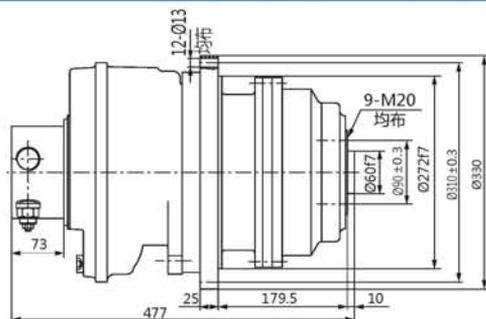

液压原理图  
Hydraulic schematic diagram

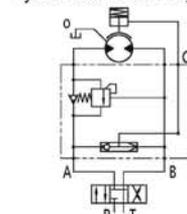

### ◆输出轴尺寸 / Shaft dimensions

B型平键输出 Cylindrical B

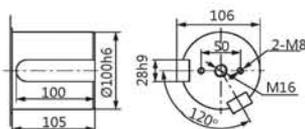

C型螺纹法兰输出 Threaded flange C

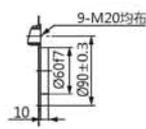

F型矩形花键输出 Rectangle splined F

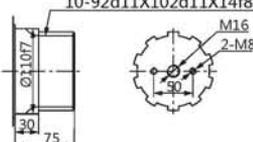

I型内花键输出 Rectangle internal spline I

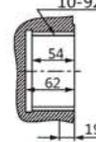

型号 Model	总排量 (ml/r) Total displacement	额定扭矩 (N.m) Rated torque	转速范围 Speed	总效率 Total efficiency	液压马达型号 Hydraulic motor	行星减速器型号 Planetary gearbox	制动器型号 Brake
		20MPa					
CFH3-1700	1735	4823	0-90	0.88-0.9	CM2-350	C3-5	CZ3
CFH3-1900	1908	5306	0-80	0.88-0.9	CM2-350	C3-5.5	CZ3
CFH3-2300	2338	6492	0-75	0.88-0.9	CM2-420	C3-5.5	CZ3

注：外形联结尺寸及输出轴有特殊要求，请与我们联系 / Note: Please contact us if there are any requirements from customer

# CFH系列液压传动/回转装置

## CFH4 液压传动装置 CFH4 Hydraulic Transmission Devices

### ◆无制动器 / Without brake

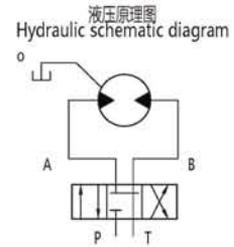
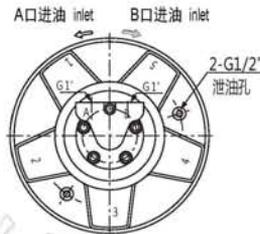
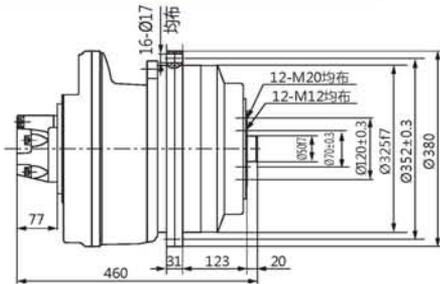

### ◆带制动器 (外置式) / With brake and external installation

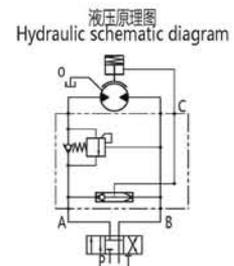
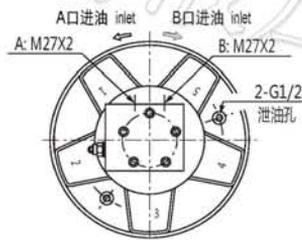
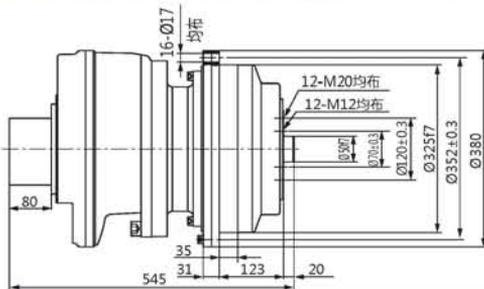

### ◆带制动器 (内置式) / With brake and internal installation

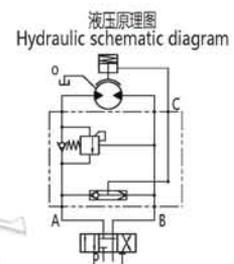
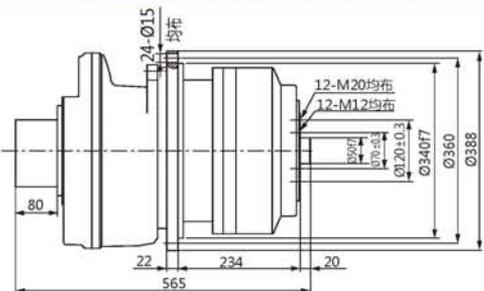

### ◆输出轴尺寸 / Shaft dimensions

B型平键输出 Cylindrical B

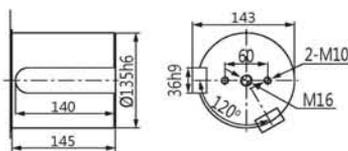

C型螺纹法兰输出 Threaded flange C

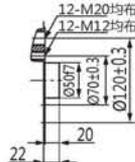

F型矩形花键输出 Rectangle splined F

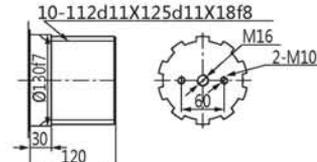

I型内花键输出 Rectangle internal spline I

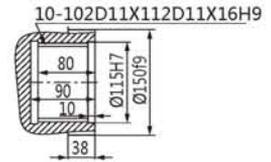

型号 Model	总排量 (ml/r) Total displacement	额定扭矩 (N.m) Rated torque	转速范围 Speed	总效率 Total efficiency	液压马达型号 Hydraulic motor	行星减速器型号 Poanetary gearbox	制动器型号 Brake
		20MPa					
CFH4-2450	2430	6860	0-80	0.9-0.91	CM3-500	C4-5	CZ4
CFH4-3000	2975	8398	0-80	0.9-0.91	CM3-600	C4-5	CZ4
CFH4-3500	3450	9774	0-80	0.9-0.91	CM3-700	C4-5	CZ4
CFH4-4000	3960	11222	0-80	0.9-0.91	CM3-800	C4-5	CZ4
CFH4-4400	4356	12344	0-70	0.9-0.91	CM3-800	C4-5.5	CZ4
CFH4-4800	4801	13538	0-70	0.9-0.91	CM3-900	C4-5.5	CZ4

注：外形联结尺寸及输出轴有特殊要求，请与我们联系 / Note: Please contact us if there are any requirements from customer

# CFH系列液压传动/回转装置

## CFH5 液压传动装置 CFH5 Hydraulic Transmission Devices

### ◆无制动器 / Without brake

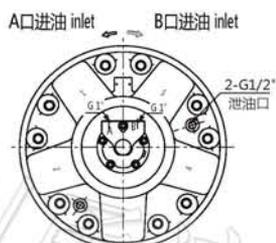
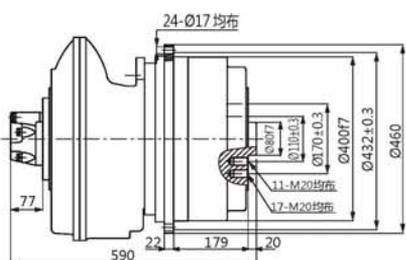

液压原理图  
Hydraulic schematic diagram

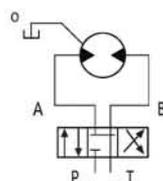

### ◆带制动器 (外置式) / With brake and external installation

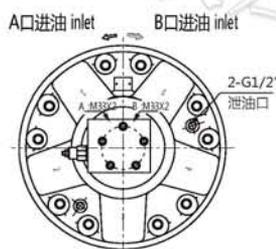
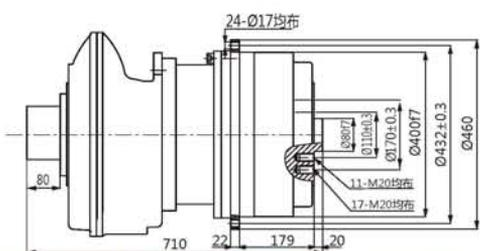

液压原理图  
Hydraulic schematic diagram

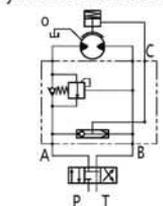

### ◆带制动器 (内置式) / With brake and internal installation

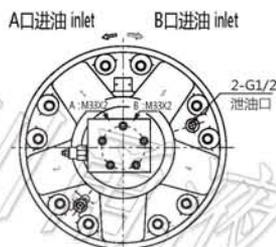
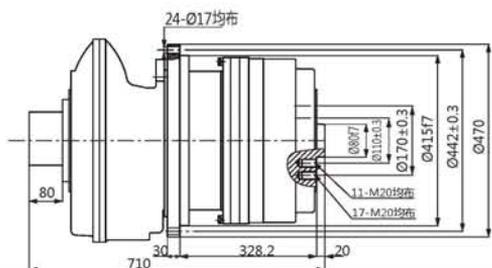

液压原理图  
Hydraulic schematic diagram

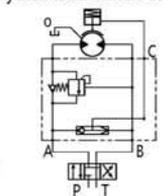

### ◆输出轴尺寸 / Shaft dimensions

B型平键输出 Cylindrical B

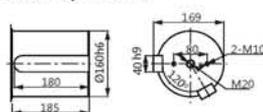

C型螺纹法兰输出 Threaded flange C

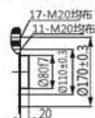

F型矩形花键输出 Rectangle splined F

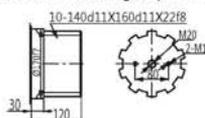

I型内花键输出 Rectangle internal spline I

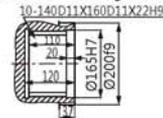

型号 Model	总排量 (ml/r) Total displacement	额定扭矩 (N.m) Rated torque	转速范围 Speed	总效率 Total efficiency	液压马达型号 Hydraulic motor	行星减速器型号 Planetary gearbox	制动器型号 Brake
		20MPa					
CFH5-5200	5195	14596	0-70	0.9-0.91	CM5-1000	C5-5	CZ5
CFH5-5700	5714	16056	0-65	0.9-0.91	CM5-1000	C5-5.5	CZ5
CFH5-6000	5925	16742	0-70	0.9-0.91	CM5-1200	C5-5	CZ5
CFH5-6700	6700	18915	0-70	0.9-0.91	CM5-1300	C5-5	CZ5
CFH5-7300	7310	20634	0-70	0.9-0.91	CM5-1450	C5-5	CZ5
CFH5-8150	8170	22987	0-70	0.9-0.91	CM5-1600	C5-5	CZ5
CFH5-9000	9080	25612	0-70	0.9-0.91	CM5-1800	C5-5	CZ5
CFH5-10000	9988	28173	0-60	0.9-0.91	CM5-1800	C5-5.5	CZ5
CFH5-11000	11039	31159	0-50	0.9-0.91	CM5-2000	C5-5.5	CZ5

注：外形联结尺寸及输出轴有特殊要求，请与我们联系 / Note: Please contact us if there are any requirements from customer

# CFH系列液压传动/回转装置

## CFH6 液压传动装置 CFH6 Hydraulic Transmission Devices

### ◆无制动器 / Without brake

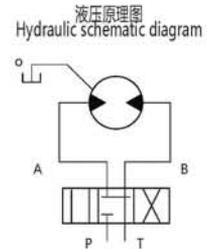
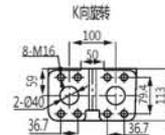
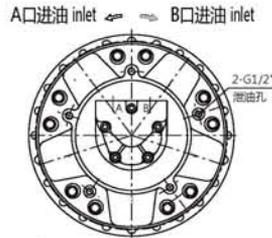
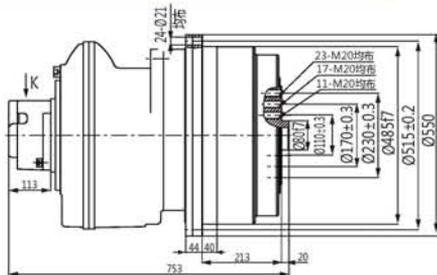

### ◆带制动器 (外置式) / With brake and external installation

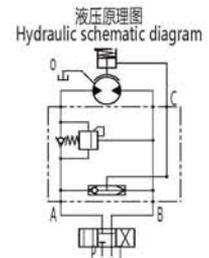
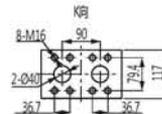
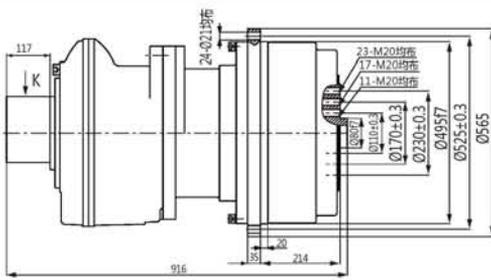

### ◆带制动器 (内置式) / With brake and internal installation

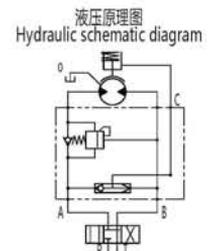
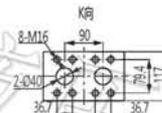
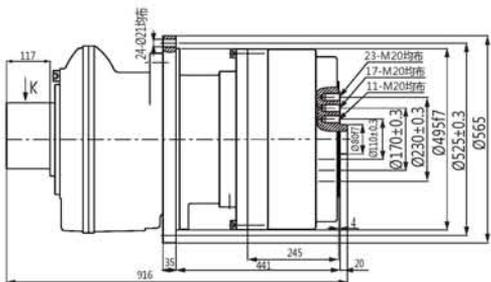

### ◆输出轴尺寸 / Shaft dimensions

B型平键输出 Cylindrical B

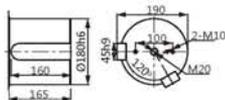

C型螺纹法兰输出 Threaded flange C

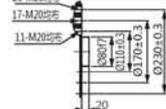

F型矩形花键输出 Rectangle splined F

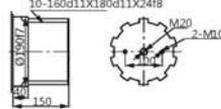

I型内花键输出 Rectangle internal spline I

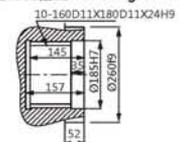

型号 Model	总排量 (ml/r) Total displacement	额定扭矩 (N.m) Rated torque	转速范围 Speed	总效率 Total efficiency	液压马达型号 Hydraulic motor	行星减速器型号 Planetary gearbox	制动器型号 Brake
		20MPa					
CFH6-10500	12468	30046	0-40	0.9-0.91	CM6-2100	C6-5	CZ6
CFH6-12500	12565	35476	0-40	0.9-0.91	CM6-2500	C6-5	CZ6
CFH6-15200	15205	42987	0-40	0.9-0.91	CM6-3000	C6-5	CZ6
CFH6-16500	16725	47286	0-30	0.9-0.91	CM6-3000	C6-5.5	CZ6
CFH6-20000	19860	57141	0-30	0.9-0.91	CM7-3600	C6-5.5	CZ6

注：外形联结尺寸及输出轴有特殊要求，请与我们联系 / Note: Please contact us if there are any requirements from customer

# CFH系列液压传动/回转装置

## CFH7 液压传动装置 CFH7 Hydraulic Transmission Devices

### ◆无制动器 / Without brake

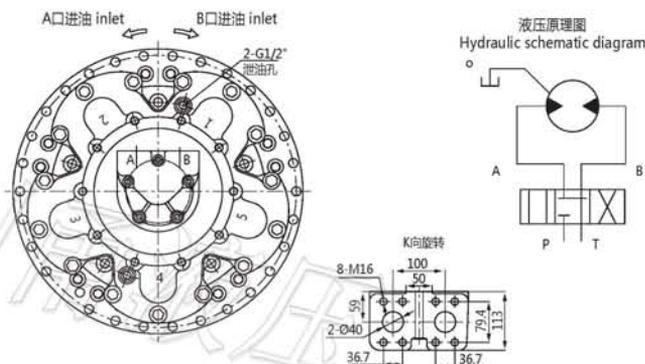
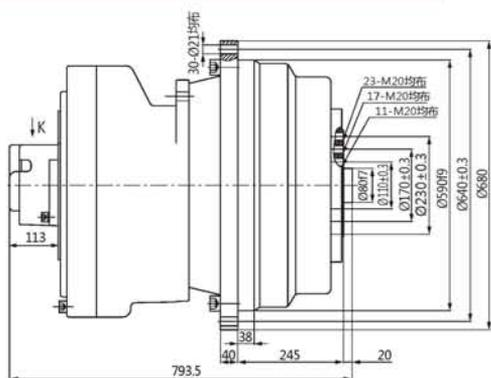

### ◆带制动器 (内置式) / With brake and internal installation

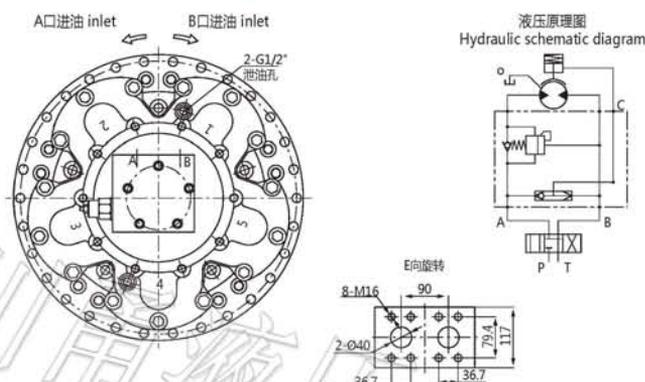
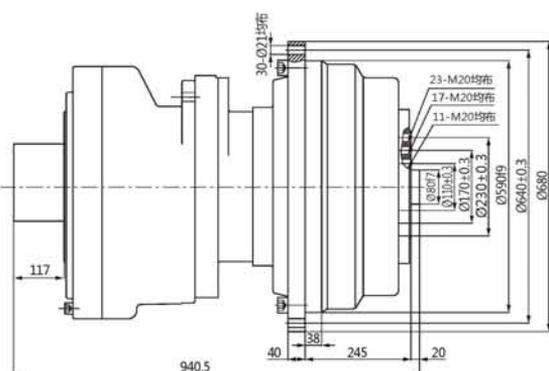

### ◆输出轴尺寸 / Shaft dimensions

B型平键输出 Cylindrical B

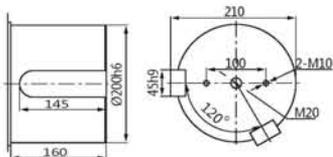

C型螺纹法兰输出 Threaded flange C

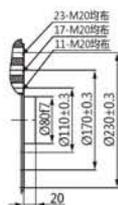

F型矩形花键输出 Rectangle splined F

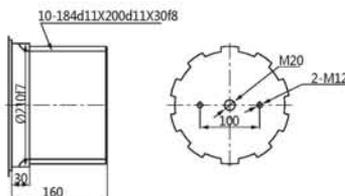

I型内花键输出 Rectangle internal spline I

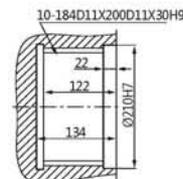

型号 Model	总排量 (ml/r) Total displacement	额定扭矩 (N.m) Rated torque	转速范围 Speed	总效率 Total efficiency	液压马达型号 Hydraulic motor	行星减速器型号 Planetary gearbox	制动器型号 Brake
		20MPa					
CFH7-15200	14925	42995	0-35	0.9-0.91	CM7-3000	C7-5	CZ7
CFH7-16500	16450	47332	0-35	0.9-0.91	CM7-3300	C7-5	CZ7
CFH7-18000	18055	51947	0-35	0.9-0.91	CM7-3600	C7-5	CZ7
CFH7-21500	21490	61902	0-35	0.9-0.91	CM7-4300	C7-5	CZ7
CFH7-23650	23639	68092	0-30	0.9-0.91	CM7-4300	C7-5.5	CZ7

注：外形联结尺寸及输出轴有特殊要求，请与我们联系 / Note: Please contact us if there are any requirements from customer

# CFH系列液压传动/回转装置

## CFH9 液压传动装置 CFH9 Hydraulic Transmission Devices

### ◆无制动器 / Without brake

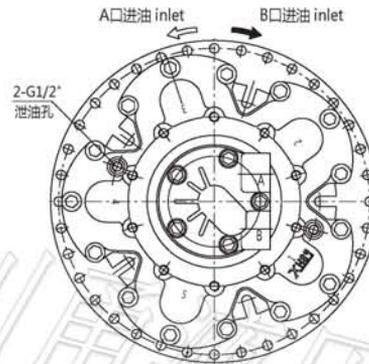
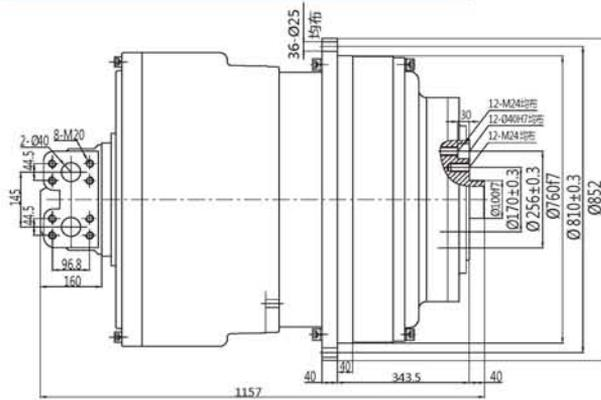

液压原理图  
Hydraulic schematic diagram

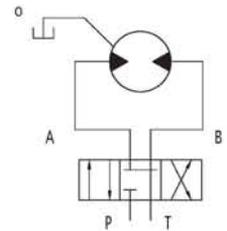

### ◆带制动器 (外置式) / With brake and external installation

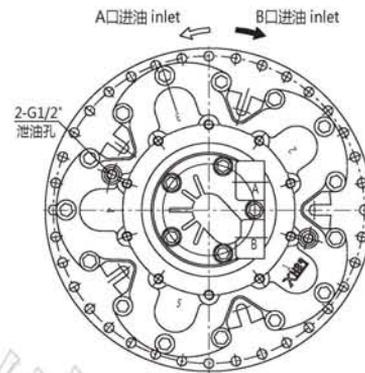
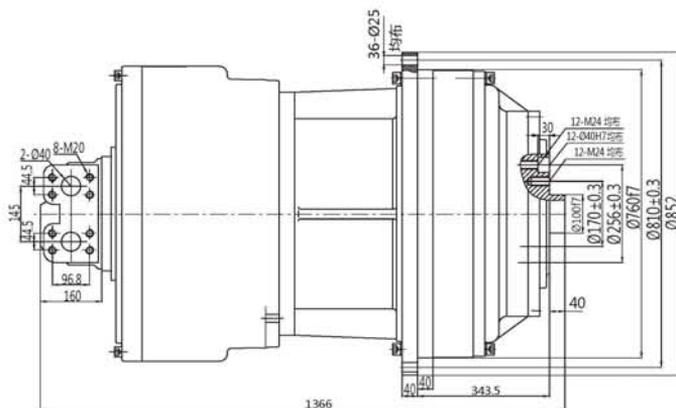

液压原理图  
Hydraulic schematic diagram

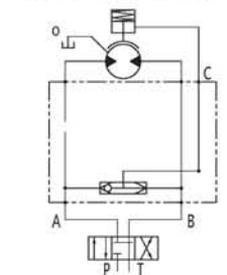

### ◆输出轴尺寸 / Shaft dimensions

B型平键输出 Cylindrical B

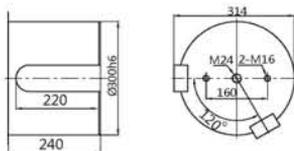

C型螺纹法兰输出 Threaded flange C

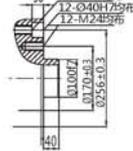

F型矩形花键输出 Rectangle splined F

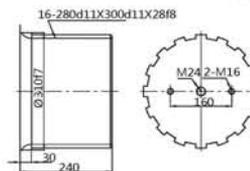

I型内花键输出 Rectangle internal spline I

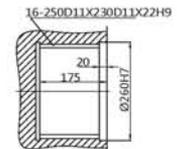

型号 Model	总排量 (ml/r) Total displacement	额定扭矩 (N.m) Rated torque		转速范围 Speed	总效率 Total efficiency	液压马达型号 Hydraulic motor	行星减速器型号 Poanetary gearbox	制动器型号 Brake
		16MPa	20MPa					
CFH9-23000	23090	51744	64680	0~15	0.9~0.91	CM9-4600	C9~5.0	CZ9
CFH9-28500	28270	63360	79200	0~15	0.9~0.91	CM9-5700	C9~5.0	CZ9
CFH9-33000	33180	74342	92928	0~15	0.9~0.91	CM9-6600	C9~5.0	CZ9
CFH9-38500	38480	86240	107800	0~15	0.9~0.91	CM9-7700	C9~5.0	CZ9
CFH9-44000	44180	98982	—	0~15	0.9~0.91	CM9-8800	C9~5.0	CZ9
CFH9-48400	48598	108880	—	0~15	0.9~0.91	CM9-8800	C9~5.5	CZ9
CFH9-55000	55291	123904	—	0~15	0.9~0.91	CM9-10000	C9~5.5	CZ9
CFH9-66000	66143	148220	—	0~15	0.9~0.91	CM9-12000	C9~5.5	CZ9

注：外形联结尺寸及输出轴有特殊要求，请与我们联系 / Note: Please contact us if there are any requirements from customer

# CFH系列液压传动/回转装置

## CFH2.53 液压传动装置 CFH2.53 Hydraulic Transmission Devices

### ◆无制动器 / Without brake

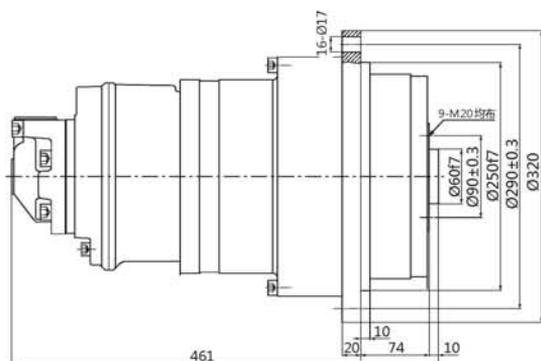

A口进油 inlet      B口进油 inlet



液压原理图  
Hydraulic schematic diagram

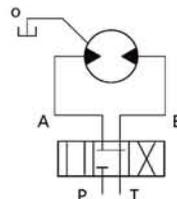

### ◆带制动器 (外置式) / With brake and external installation

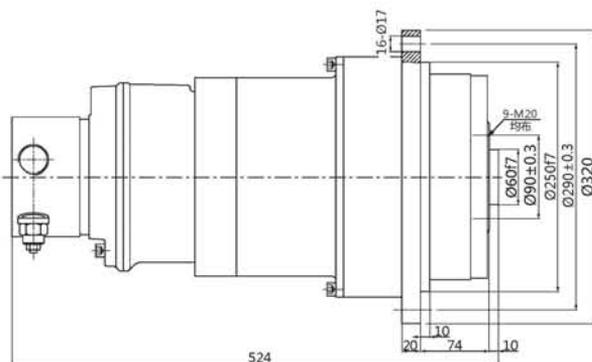

A口进油 inlet      B口进油 inlet



液压原理图  
Hydraulic schematic diagram

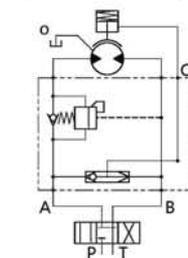

### ◆输出轴尺寸 / Shaft dimensions

B型平键输出 Cylindrical B

C型螺纹法兰输出 Threaded flange C

F型矩形花键输出 Rectangle splined F

I型内花键输出 Rectangle internal spline I

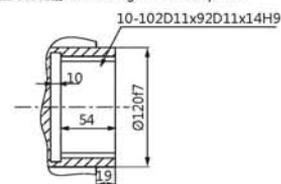
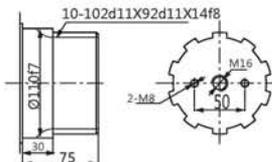
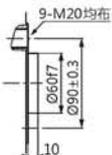
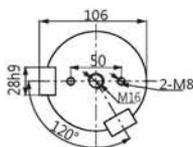
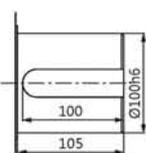

型号 Model	总排量 (ml/r) Total displacement	额定扭矩 (N.m) Rated torque		转速范围 Speed	总效率 Total efficiency	液压马达型号 Hydraulic motor	行星减速器型号 Poanetary gearbox	制动器型号 Brake
		16MPa	20MPa					
CFH2.53-1700	1720	3864	4829	0-19	0.88-0.9	CM 05-90	C2.53-20	CZ2.5
CFH2.53-2300	2300	5159	6448	0-19	0.88-0.9	CM 05-110	C2.53-20	CZ2.5
CFH2.53-2600	2580	5778	7223	0-19	0.88-0.9	CM 05-130	C2.53-20	CZ2.5
CFH2.53-3000	3020	6758	8448	0-19	0.88-0.9	CM 05-150	C2.53-20	CZ2.5
CFH2.53-3300	3320	7434	9293	0-19	0.88-0.9	CM 05-170	C2.53-20	CZ2.5
CFH2.53-3800	3820	8560	9856	0-19	0.88-0.9	CM 05-200	C2.53-20	CZ2.5

注：外形联结尺寸及输出轴有特殊要求，请与我们联系 / Note: Please contact us if there are any requirements from customer



# CFH系列液压传动/回转装置

## CFH45 液压传动装置 CFH45 Hydraulic Transmission Devices

### ◆无制动器 / Without brake

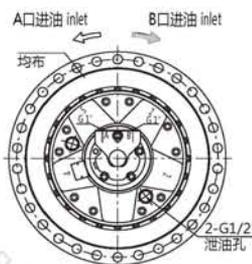
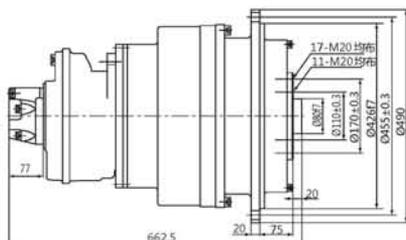

液压原理图  
Hydraulic schematic diagram

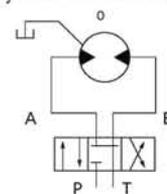

### ◆带制动器 (外置式) / With brake and external installation

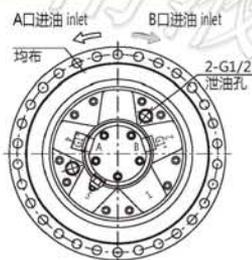
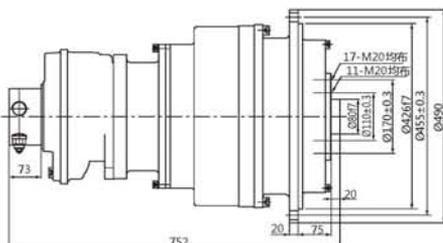

液压原理图  
Hydraulic schematic diagram

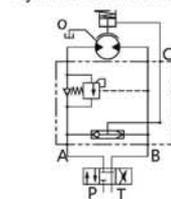

### ◆带制动器 (内置式) / With brake and internal installation

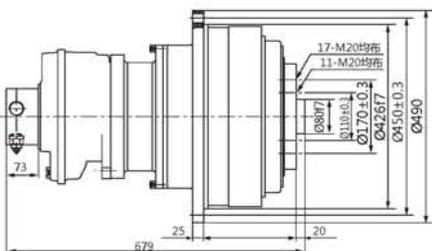

液压原理图  
Hydraulic schematic diagram

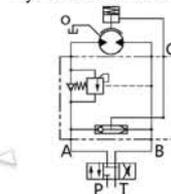

### ◆输出轴尺寸 / Shaft dimensions

B型平键输出 Cylindrical B

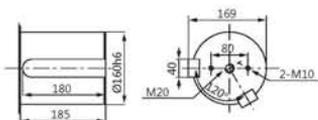

C型螺纹法兰输出 Threaded flange C



F型矩形花键输出 Rectangle splined F

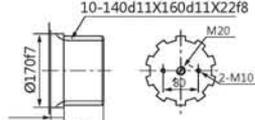

I型内花键输出 Rectangle internal spline I

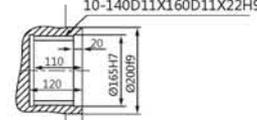

型号 Model	总排量 (ml/r) Total displacement	额定扭矩 (N.m) Rated torque		转速范围 Speed	总效率 Total efficiency	液压马达型号 Hydraulic motor	行星减速器型号 Poanetary gearbox	制动器型号 Brake
		16MPa	20MPa					
CFH45-7000	6940	15263	19078	0-15	0.88-0.9	CM2-350	C45-20	CZ4
CFH45-8500	8500	18646	23344	0-15	0.88-0.9	CM2-420	C45-20	CZ4
CFH45-10000	9826	21661	27046	0-15	0.88-0.9	CM2-500	C45-20	CZ4
CFH45-12000	11900	26146	32682	0-11	0.88-0.9	CM2-420	C45-28	CZ4
CFH45-14000	13804	30325		0-11	0.88-0.9	CM2-500	C45-28	CZ4

注：外形联结尺寸及输出轴有特殊要求，请与我们联系 / Note: Please contact us if there are any requirements from customer

# CFH系列液压传动/回转装置

## CFH56 液压传动装置 CFH56 Hydraulic Transmission Devices

### ◆无制动器 / Without brake

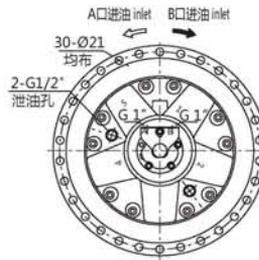
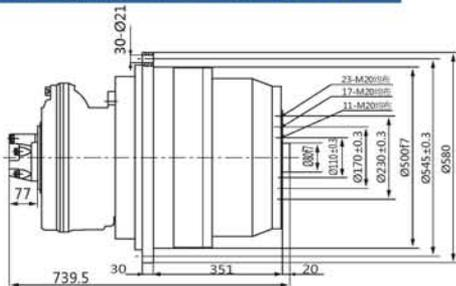

液压原理图  
Hydraulic schematic diagram

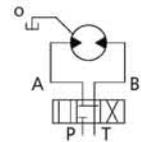

### ◆带制动器 (外置式) / With brake and external installation

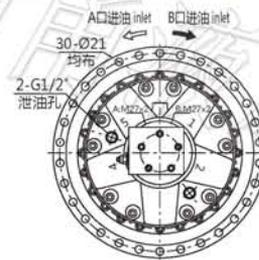
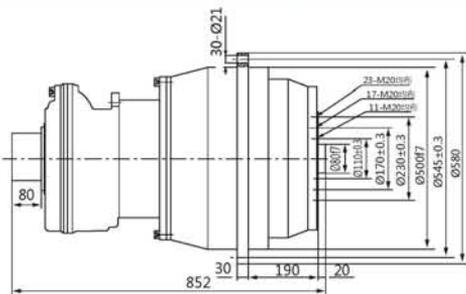

液压原理图  
Hydraulic schematic diagram

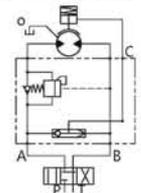

### ◆带制动器 (内置式) / With brake and internal installation

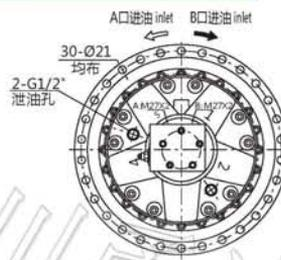
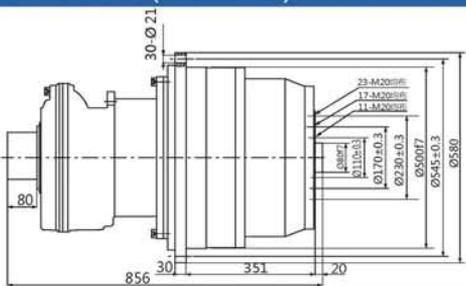

液压原理图  
Hydraulic schematic diagram

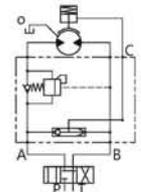

### ◆输出轴尺寸 / Shaft dimensions

B型平键输出 Cylindrical B

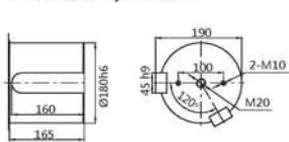

C型螺纹法兰输出 Threaded flange C

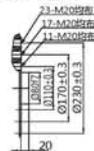

F型矩形花键输出 Rectangle splined F

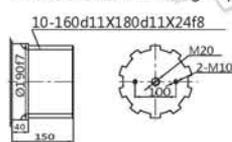

I型内花键输出 Rectangle internal spline I

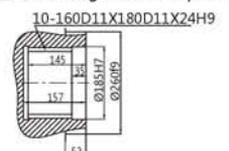

型号 Model	总排量 (ml/r) Total displacement	额定扭矩 (N.m) Rated torque		转速范围 Speed	总效率 Total efficiency	液压马达型号 Hydraulic motor	行星减速器型号 Poanetary gearbox	制动器型号 Brake
		16MPa	20MPa					
CFH56-12000	12320	27067	33834	0-14	0.88-0.9	CM4-600	C56-20	CZ5
CFH56-16000	15860	34918	43648	0-14	0.88-0.9	CM4-800	C56-20	CZ5
CFH56-18000	18080	39706	49632	0-14	0.88-0.9	CM4-900	C56-20	CZ5
CFH56-20000	20440	45056	56320	0-14	0.88-0.9	CM4-1000	C56-20	CZ5
CFH56-22000	22204	48885	61106	0-10	0.88-0.9	CM4-800	C56-28	CZ5
CFH56-25000	25312	55587		0-10	0.88-0.9	CM4-900	C56-28	CZ5
CFH56-28000	28616	63078		0-10	0.88-0.9	CM4-1000	C56-28	CZ5

注：外形联结尺寸及输出轴有特殊要求，请与我们联系 / Note: Please contact us if there are any requirements from customer



# CFH系列液压传动/回转装置

## CFH79 液压传动装置 CFH79 Hydraulic Transmission Devices

### ◆无制动器 / Without brake

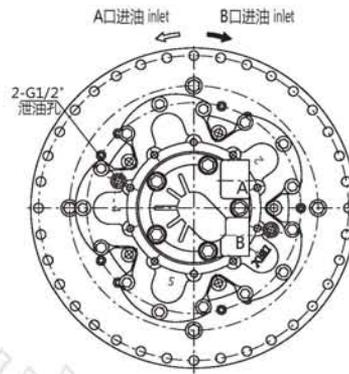
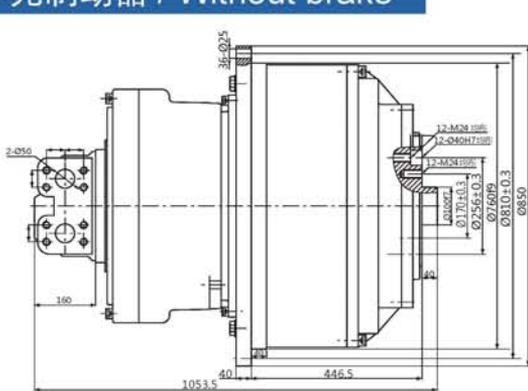

液压原理图  
Hydraulic schematic diagram

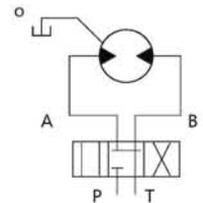

### ◆带制动器 (外置式) / With brake and external installation

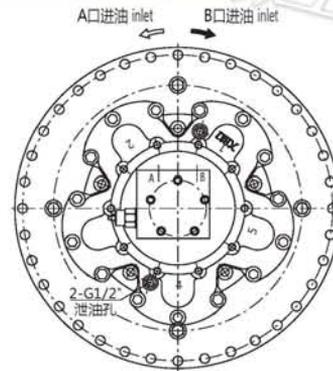
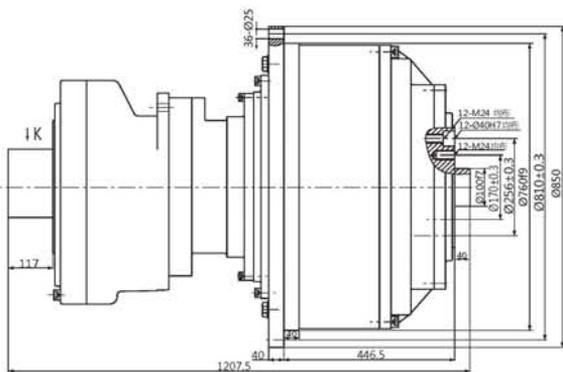

液压原理图  
Hydraulic schematic diagram

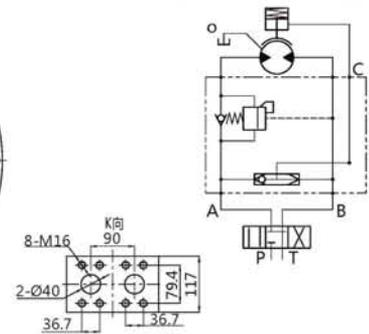

### ◆输出轴尺寸 / Shaft dimensions

B型平键输出 Cylindrical B

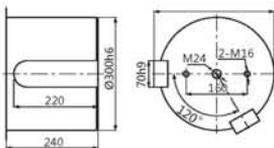

C型螺纹法兰输出 Threaded flange C

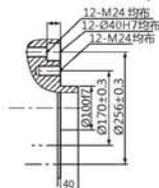

F型矩形花键输出 Rectangle splined F

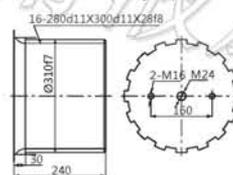

I型内花键输出 Rectangle internal spline I

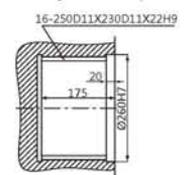

型号 Model	总排量 (ml/r) Total displacement	额定扭矩 (N.m) Rated torque		转速范围 Speed	总效率 Total efficiency	液压马达型号 Hydraulic motor	行星减速器型号 Poanetary gearbox	制动器型号 Brake
		16MPa	20MPa					
CFH79-40000	40140	89830	112288	0-9	0.88-0.9	CM7-2000	C79-20	CZ7
CFH79-50000	50520	113203	141504	0-9	0.88-0.9	CM7-2500	C79-20	CZ7
CFH79-60000	59700	133782	167228	0-8	0.88-0.9	CM7-3000	C79-20	CZ7
CFH79-66000	65800	147277	182623	0-8	0.88-0.9	CM7-3300	C79-20	CZ7
CFH79-72000	72220	161638		0-7	0.88-0.9	CM7-3600	C79-20	CZ7
CFH79-83000	83580	187290		0-6	0.88-0.9	CM7-3000	C79-28	CZ7

注：外形联结尺寸及输出轴有特殊要求，请与我们联系 / Note: Please contact us if there are any requirements from customer

## CFX 液压传动装置 CFX Hydraulic Transmission Devices

### ◆型号说明 / Description of Model

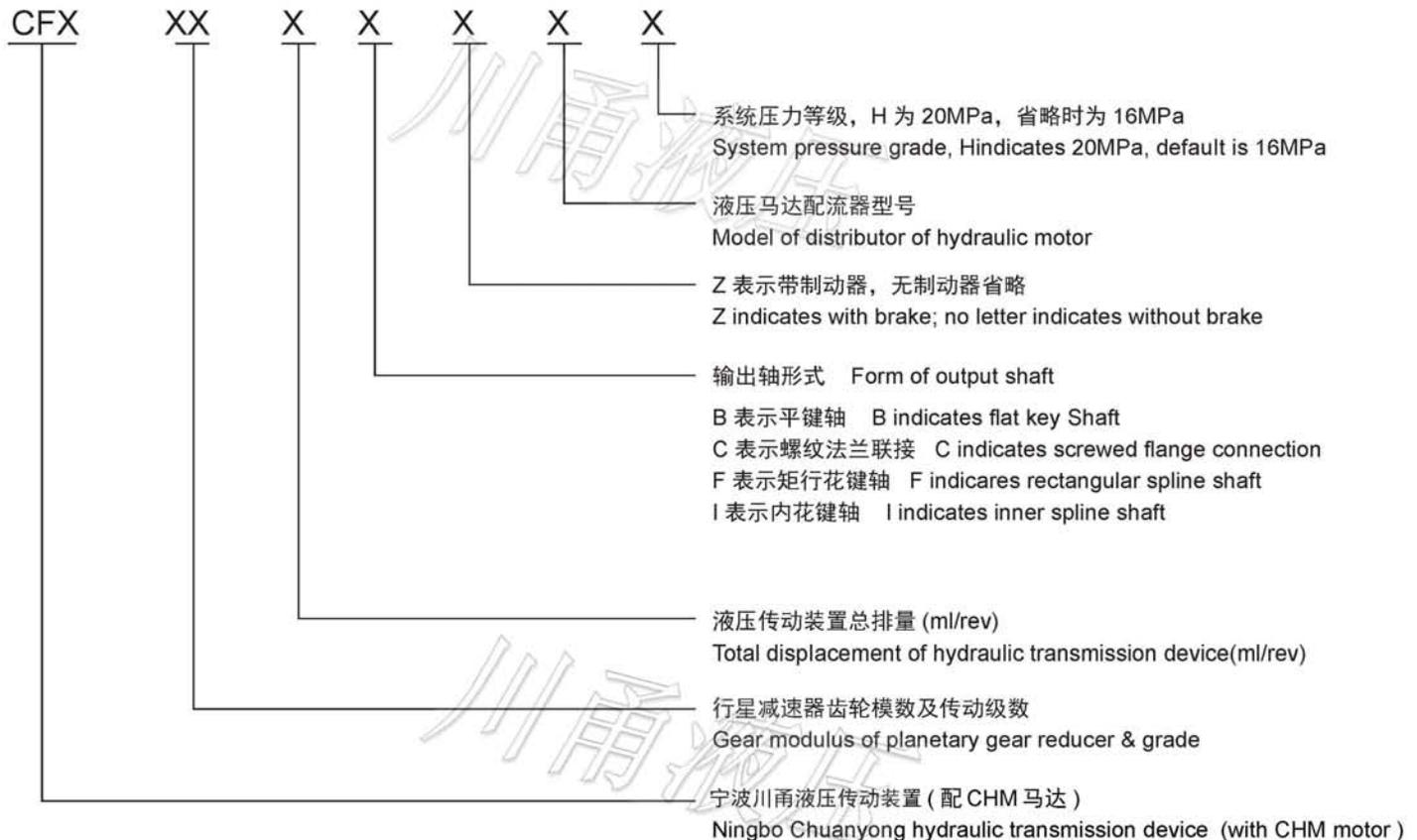

### ◆参数说明 / Description on Parameters

- (1)、总排量为液压马达排量乘以减速传动比。  
The total displacement is calculated by multiplying hydraulic motor displacement with reduction transmission ratio.
- (2)、额定扭矩是在系统压力为 16MPa 或 20MPa 时, 考虑传动效率后的实际输出扭矩。  
Rated torque is the actual output torque taking transmission efficiency into account when system pressure is 16MPa or 20MPa.
- (3)、传动效率包括液压马达的机械效率和行星减速器机械效率。  
Transmission efficiency includes the mechanical efficiency of hydraulic motor and the mechanical efficiency of planetary reducer.

### ◆选型举例 / Example of Model Selection

CFX3 1000CD31 H 表示该液压传动装置采用单级行星减速器传动, 齿轮箱模数为 3, 总排量为 1000ml/rev, 输出轴采用螺纹联接, 液压马达配流器 D31, 额定压力等级为 20MPa。

CFX3 1000CD31 H means the hydraulic transmission device adopts single-grade planetary reducer transmission with modulus of gearbox being 3 and total displacement of 1000ml/rev; the output shaft adopts screwed connection. Hydraulic motor distributor is D31 and the rated pressure grade is 20MPa.

## ◆选型说明 /Description on Selection of Model

- (1)、CFX 液压传动装置允许在高压下工作。
- (2)、壳体允许最高压力为 0.8MPa，如有特殊要求，请与厂家联系。
- (3)、液压油：建议使用高质量、防泡沫、抗氧化的矿基液压油，理想工作油温 30°C ~50°C，允许油温 -20°C ~80°C，当油温低于 10°C 时，必须用低凝液压油。液压油的粘度为 40~60 厘拖，允许为 5~300 厘拖。
- (4)、液压油过滤精度推荐为 25 μm，或更高过滤精度。
- (5)、液压传动装置均可双向旋转，具体转向见附图。如用户要求与图示转向相反，请在订货时注明。
- (6)、泄油管定位：CFX 传动装置允许任何方向安装，为保证马达内各运动副的润滑，要求在工作之前将马达内充满液压油，泄油口位置的选择必须保证运转中壳体充满液压油。
- (7)、配流器的选择：各种液压传动装置可以根据不同工况要求选用各种规格的配流器，选择配流器的原则按使用压力、转速、流量、联接方式和所集成阀组要求来考虑；配流器安装：配流器进出油口方向允许按外形安装联接位置以 72 度为间隔旋转，但当松开螺钉旋转时，要当心不能损坏平面 O 形圈的密封功能。

- (1)、CFX hydraulic transmission device can work under high pressure.
- (2)、The max permissible pressure of the housing is 0.8MPa. If you have any special requirements, please contact the manufacturer.
- (3)、Hydraulic oil: recommend using high quality, anti-foaming and anti-oxidation mineral hydraulic oil. The ideal working oil temperature is 30°C to 50°C and the permissible oil temperature is between -20 °C to 80 °C When oil temperature is lower than 10°C . Low-freezing hydraulic oil must be used. The viscosity of hydraulic oil is between 40-60 CST centistokes and the permissible viscosity is 5-300 CST centistokes.
- (4)、The recommended hydraulic oil filtering precision is 25 μm or higher;
- (5)、The hydraulic transmission device can rotate in both directions; please see the details in the attached charts. If users require the equipment to rotate in opposite direction, please make notes when you place orders.
- (6)、Positioning of oil drain: CFX transmission device allows to be installed in any direction . To ensure the lubrication of all kinematic pair, it's required to fill hydraulic oil into the motor before Working. The selection of position of oil drain port must be able to ensure that the housing is full of hydraulic oil when it operates;
- (7)、Selection of distributor: All sorts of hydraulic transmission device can select to use the distributors of various specifications according to the requirements of different working conditions The principle for selection of distributor: to select distributor according to the using pressure, rotation speed, flow, connecting method and the requirements of the integrated valve group; installation of distributor: the direction of oil inlet and outlet of distributors allows to rotate with interval of 72° around the external installation and connection location. However, when the distributor is rotated while the bolt is released, be careful not to damage the seal function of plane O-ring.



# CFX系列液压传动/回转装置

## CFX3 液压传动装置 CFX3 Hydraulic Transmission Devices

### ◆无制动器 / Without brake

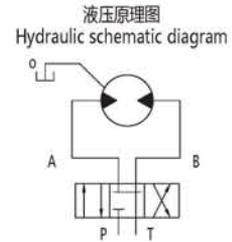
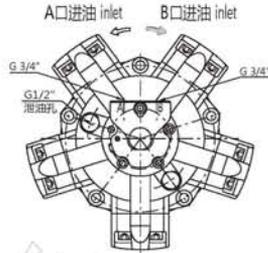
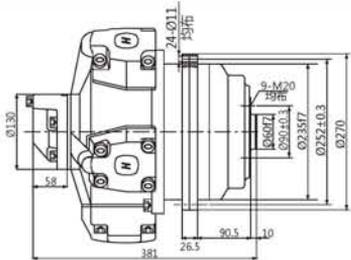

### ◆带制动器 (外置式) / With brake and external installation

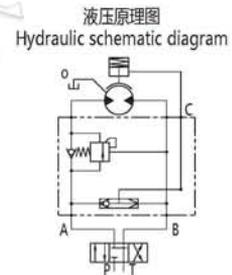
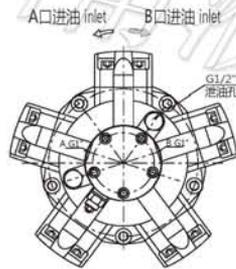
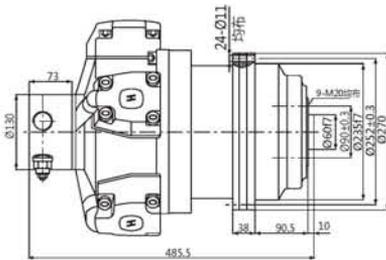

### ◆带制动器 (内置式) / With brake and internal installation

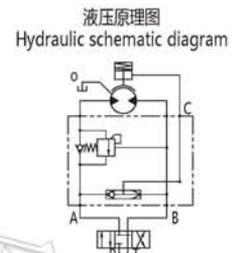
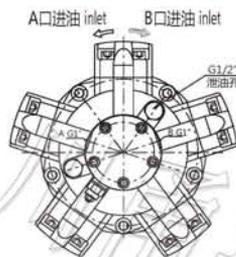
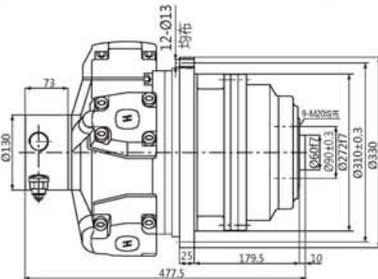

### ◆输出轴尺寸 / Shaft dimensions

B型平键输出  
Cylindrical B

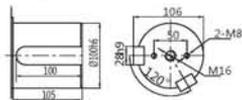

C型螺纹法兰输出  
Threaded flange C

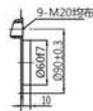

F型矩形花键输出  
Rectangle splined F

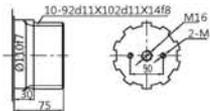

I型内花键输出  
Rectangle internal spline I

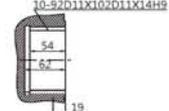

型号 Model	总排量 (ml/r) Total displacement	额定扭矩 (N.m) Rated torque		转速范围 Speed	总效率 Total efficiency	液压马达型号 Hydraulic motor	行星减速器型号 Poanetary gearbox	制动器型号 Brake
		16MPa	20MPa					
CFX3-1500	1445	3041	3081	0-80	0.88-0.9	CHM3-300	C3-5	CZ3
CFX3-1700	1700	3660	4576	0-80	0.88-0.9	CHM3-350	C3-5	CZ3
CFX3-2000	1985	4223	5279	0-80	0.88-0.9	CHM6-400	C3-5	CZ3
CFX3-2550	2260	4665	5831	0-80	0.88-0.9	CHM6-450	C3-5	CZ3
CFX3-2500	2486	5131	6414	0-70	0.88-0.9	CHM6-450	C3-5.5	CZ3
CFX3-2700	2701	5729		0-70	0.88-0.9	CHM6-500	C3-5.5	CZ3

注：外形联结尺寸及输出轴有特殊要求，请与我们联系 / Note: Please contact us if there are any requirements from customer

# CFX系列液压传动/回转装置

## CFX4 液压传动装置 CFX4 Hydraulic Transmission Devices

### ◆无制动器 / Without brake

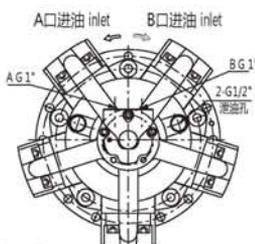
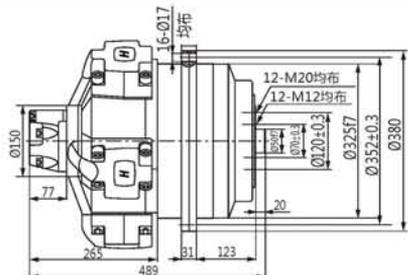

液压原理图  
Hydraulic schematic diagram

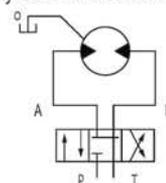

### ◆带制动器 (外置式) / With brake and external installation

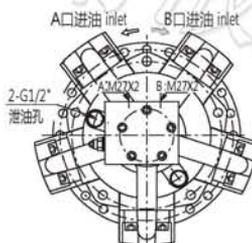
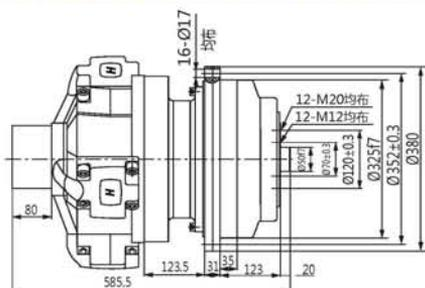

液压原理图  
Hydraulic schematic diagram

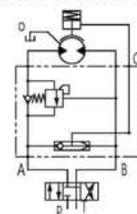

### ◆带制动器 (内置式) / With brake and internal installation

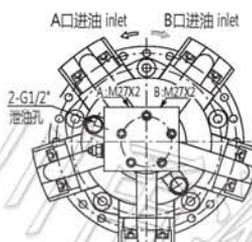
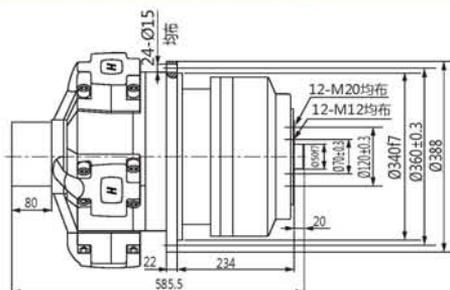

液压原理图  
Hydraulic schematic diagram

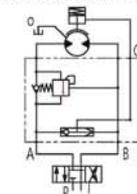

### ◆输出轴尺寸 / Shaft dimensions

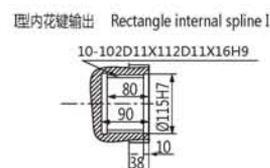
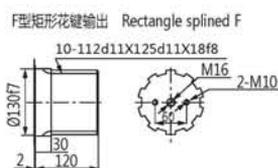
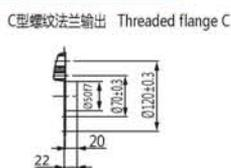
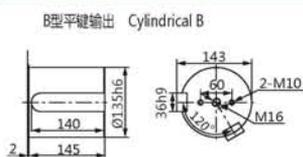

型号 Model	总排量 (ml/r) Total displacement	额定扭矩 (N.m) Rated torque		转速范围 Speed	总效率 Total efficiency	液压马达型号 Hydraulic motor	行星减速器型号 Poanetary gearbox	制动器型号 Brake
		16MPa	20MPa					
CFX4-3400	3410	7723	9655	0-55	0.9-0.91	CHM11-700	C4-5	CZ4
CFX4-3900	3910	8569	10711	0-55	0.9-0.91	CHM11-800	C4-5	CZ4
CFX4-4500	4470	10078		0-55	0.9-0.91	CHM11-900	C4-5	CZ4
CFX4-4900	4917	11086	13857	0-45	0.9-0.91	CHM11-900	C4-5.5	CZ4
CFX4-5400	5396	11734	14669	0-45	0.9-0.91	CHM11-1000	C4-5.5	CZ4
CFX4-6100	6072	13284		0-45	0.9-0.91	CHM11-1100	C4-5.5	CZ4

注：外形联结尺寸及输出轴有特殊要求，请与我们联系 / Note: Please contact us if there are any requirements from customer

# CFX系列液压传动/回转装置

## CFX5 液压传动装置 CFX5 Hydraulic Transmission Devices

### ◆无制动器 / Without brake

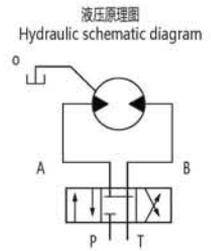
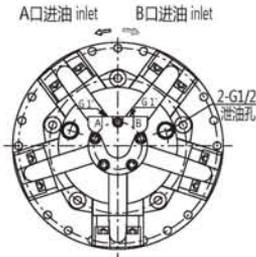
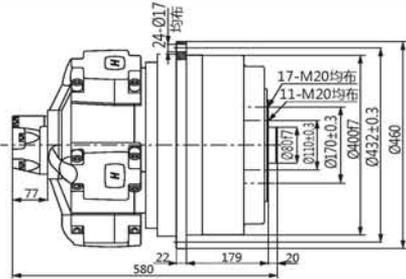

### ◆带制动器 (外置式) / With brake and external installation

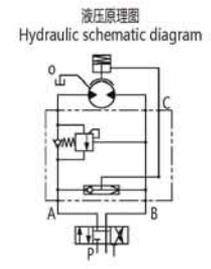
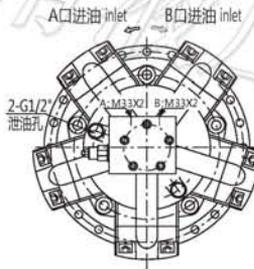
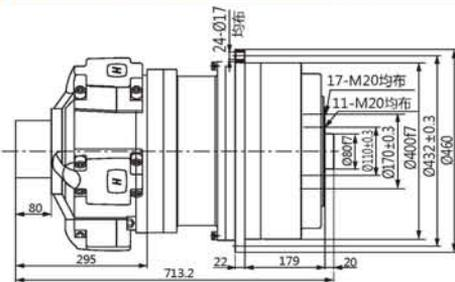

### ◆带制动器 (内置式) / With brake and internal installation

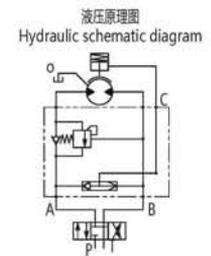
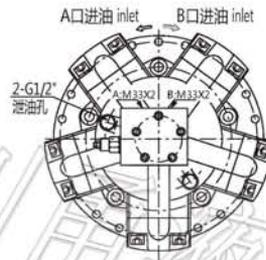
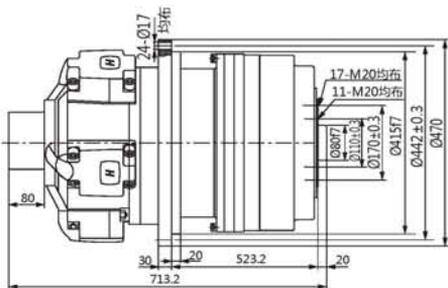

### ◆输出轴尺寸 / Shaft dimensions

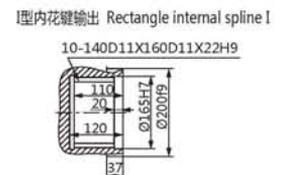
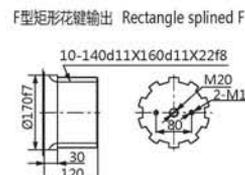
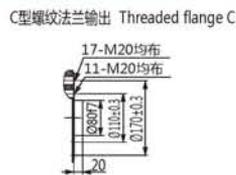
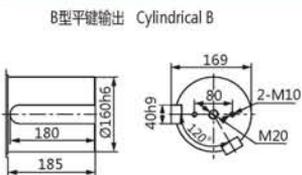

型号 Model	总排量 (ml/r) Total displacement	额定扭矩 (N.m) Rated torque		转速范围 Speed	总效率 Total efficiency	液压马达型号 Hydraulic motor	行星减速器型号 Poanetary gearbox	制动器型号 Brake
		16MPa	20MPa					
CFX5-7000	7065	14880	18600	0-40	0.9-0.91	CHM16-1400	C5-5	CZ5
CFX5-8250	8240	17834	22292	0-40	0.9-0.91	CHM16-1600	C5-5	CZ5
CFX5-9000	9070	19667	24584	0-40	0.9-0.91	CHM16-1800	C5-5	CZ5
CFX5-10000	10170	21823	27286	0-40	0.9-0.91	CHM16-2000	C5-5	CZ5
CFX5-11000	11870	24011	30014	0-35	0.9-0.91	CHM16-2000	C5-5.5	CZ5
CFX5-12500	12469	28685		0-35	0.9-0.91	CHM16-2400	C5-5.5	CZ5

注：外形联结尺寸及输出轴有特殊要求，请与我们联系 / Note: Please contact us if there are any requirements from customer

# CFX系列液压传动/回转装置

## CFX6 液压传动装置 CFX6 Hydraulic Transmission Devices

### ◆无制动器 / Without brake

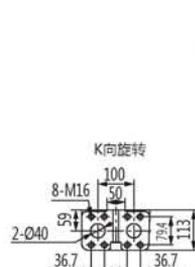
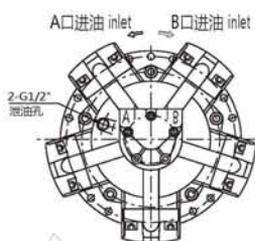
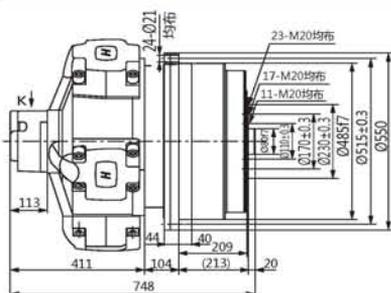

液压原理图  
Hydraulic schematic diagram

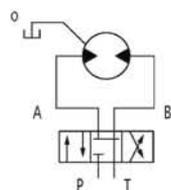

### ◆带制动器 (外置式) / With brake and external installtion

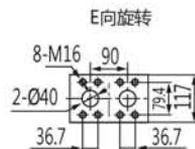
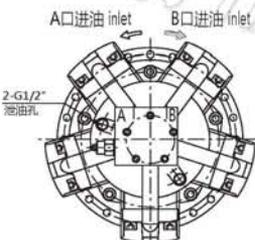
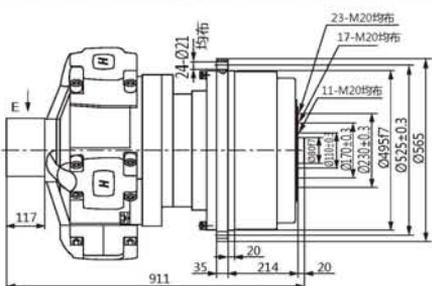

液压原理图  
Hydraulic schematic diagram

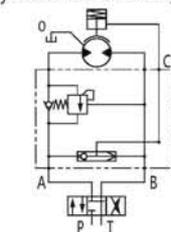

### ◆带制动器 (内置式) / With brake and internal installtion

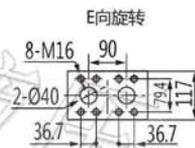
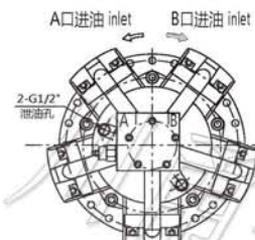
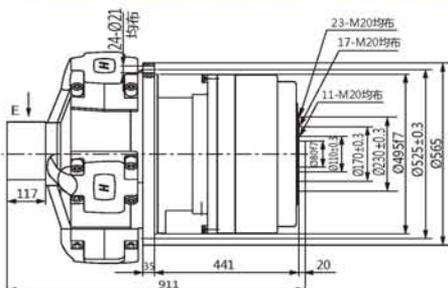

液压原理图  
Hydraulic schematic diagram

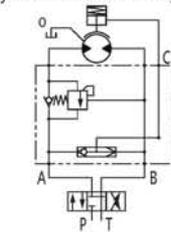

### ◆输出轴尺寸 / Shaft dimensions

B型平键输出 Cylindrical B

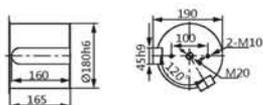

C型螺纹法兰输出 Threaded flange C

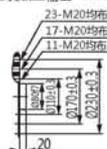

F型矩形花键输出 Rectangle splined F

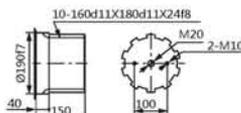

I型内花键输出 Rectangle internal spline I

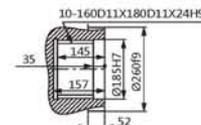

型号 Model	总排量 (ml/r) Total displacement	额定扭矩 (N.m) Rated torque		转速范围 Speed	总效率 Total efficiency	液压马达型号 Hydraulic motor	行星减速器型号 Poanetary gearbox	制动器型号 Brake
		16MPa	20MPa					
CFX6-14200	14225	29452	36815	0-25	0.9-0.91	CHM31-2800	C6-5	CZ6
CFX6-15750	15750	29028	36285	0-25	0.9-0.91	CHM31-3150	C6-5	CZ6
CFX6-17675	17630	32493	40616	0-25	0.9-0.91	CHM31-3500	C6-5	CZ6
CFX6-20000	19990	36837	46046	0-25	0.9-0.91	CHM31-4000	C6-5	CZ6
CFX6-22000	21989	40521	50561	0-20	0.9-0.91	CHM31-4000	C6-5.5	CZ6

注：外形联结尺寸及输出轴有特殊要求，请与我们联系 / Note: Please contact us if there are any requirements from customer

# CFX系列液压传动/回转装置

## CFX7 液压传动装置 CFX7 Hydraulic Transmission Devices

### ◆无制动器 / Without brake

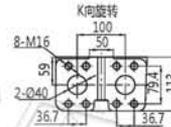
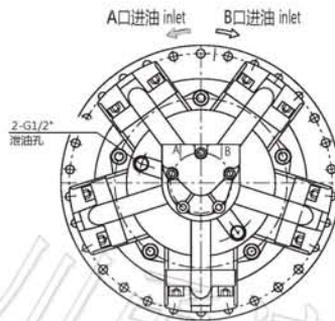
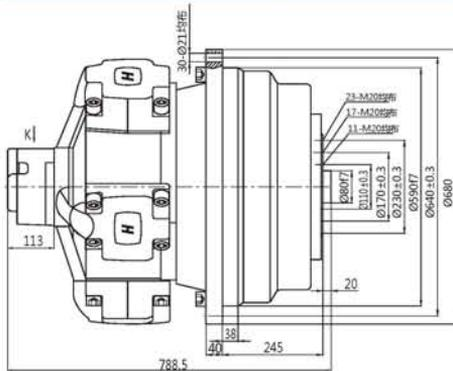

液压原理图  
Hydraulic schematic diagram

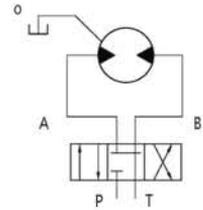

### ◆带制动器 (外置式) / With brake and external installation

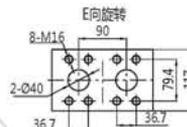
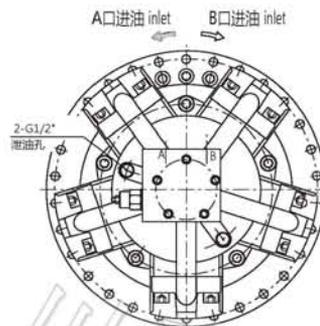
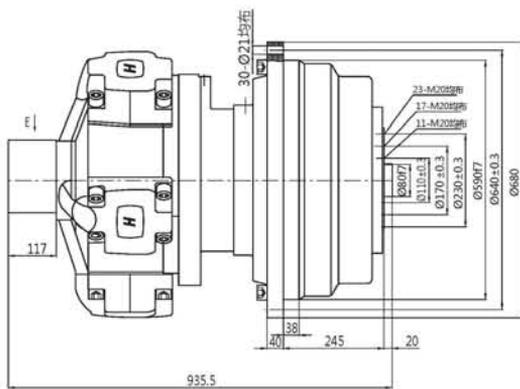

液压原理图  
Hydraulic schematic diagram

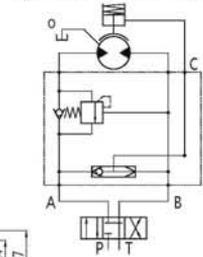

### ◆输出轴尺寸 / Shaft dimensions

B型平键输出 Cylindrical B

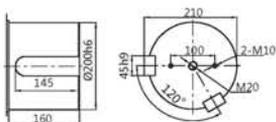

C型螺纹法兰输出 Threaded flange C

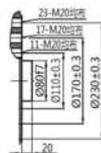

F型矩形花键输出 Rectangle splined F

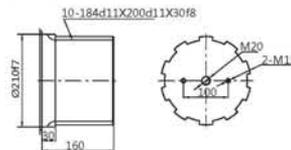

I型内花键输出 Rectangle internal spline I

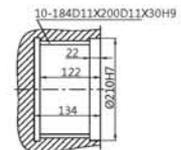

型号 Model	总排量 (ml/r) Total displacement	额定扭矩 (N.m) Rated torque		转速范围 Speed	总效率 Total efficiency	液压马达型号 Hydraulic motor	行星减速器型号 Poanetary gearbox	制动器型号 Brake
		16MPa	20MPa					
CFX7-21000	20760	44931	56165	0-22	0.9-0.91	CHM31-4000	C7-5	CZ7
CFX7-24000	24140	55741		0-22	0.9-0.91	CHM31-5000	C7-5	CZ7
CFX7-25000	24882	53789	67236	0-22	0.9-0.91	CHM31-4500	C7-5.5	CZ7
CFX7-27500	26554	61315		0-18	0.9-0.91	CHM31-5000	C7-5.5	CZ7

注：外形联结尺寸及输出轴有特殊要求，请与我们联系 / Note: Please contact us if there are any requirements from customer

# CFX系列液压传动/回转装置

## CFX9 液压传动装置 CFX9 Hydraulic Transmission Devices

### ◆无制动器 / Without brake

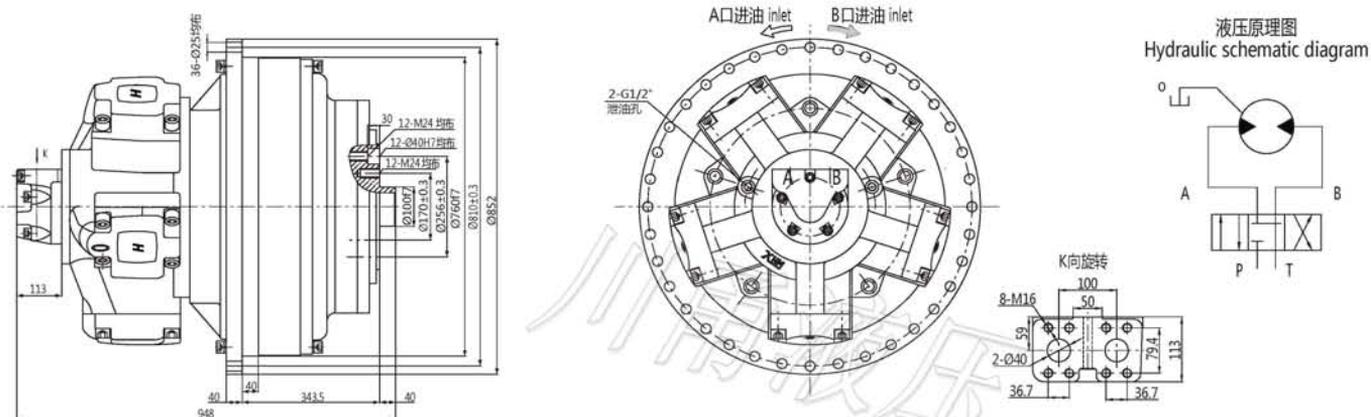

### ◆带制动器 (内置式) / With brake and internal installation

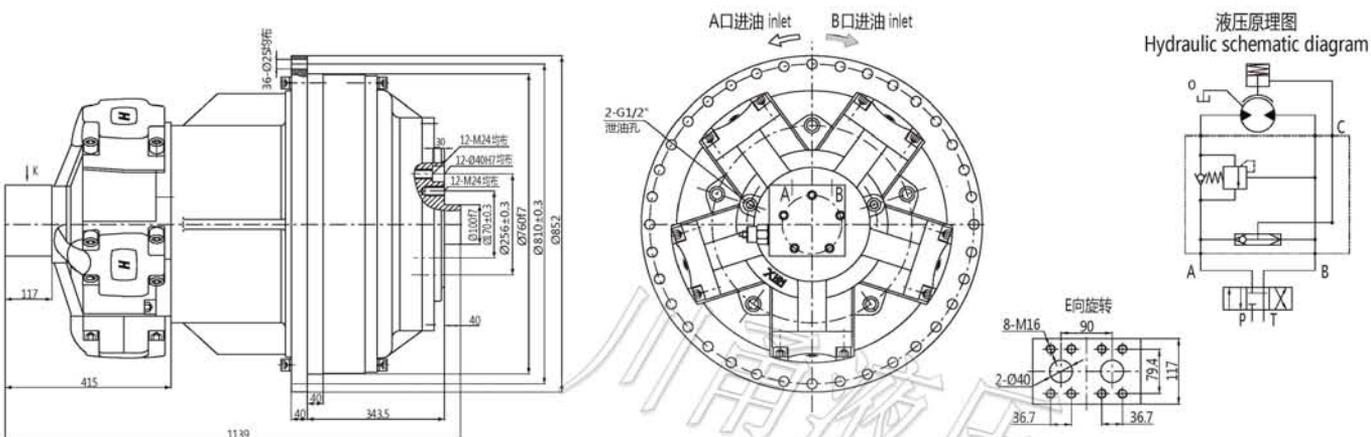

### ◆输出轴尺寸 / Shaft dimensions

B型平键输出 Cylindrical B

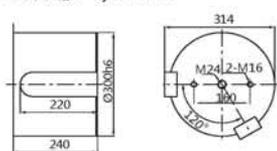

C型螺纹法兰输出 Threaded flange C

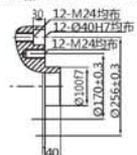

F型矩形花键输出 Rectangle splined F

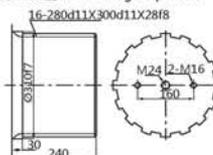

型内花键输出 Rectangle internal spline I

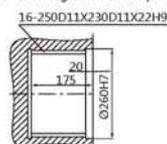

型号 Model	总排量 (ml/r) Total displacement	额定扭矩 (N.m) Rated torque		转速范围 Speed	总效率 Total efficiency	液压马达型号 Hydraulic motor	行星减速器型号 Poanetary gearbox	制动器型号 Brake
		16MPa	20MPa					
CFX9-27500	27540	62964	78705	0-20	0.9-0.91	CHM40-5500	C9-70	CZ9
CFX9-31500	31555	68688	85860	0-20	0.9-0.91	CHM40-6300	C9-70	CZ9
CFX9-35000	34916	80136	100000	0-14	0.9-0.91	CHM40-5000	C9-70	CZ9
CFX9-38500	38556	88149		0-14	0.9-0.91	CHM40-5500	C9-70	CZ9
CFX9-44000	44177	96163		0-14	0.9-0.91	CHM40-6300	C9-70	CZ9

注：外形联结尺寸及输出轴有特殊要求，请与我们联系 / Note: Please contact us if there are any requirements from customer

# CFX系列液压传动/回转装置

## CFX2.53 液压传动装置 CFX2.53 Hydraulic Transmission Devices

### ◆无制动器 / Without brake

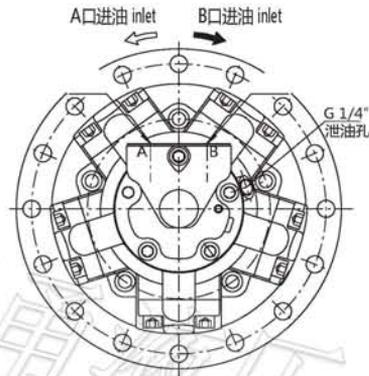
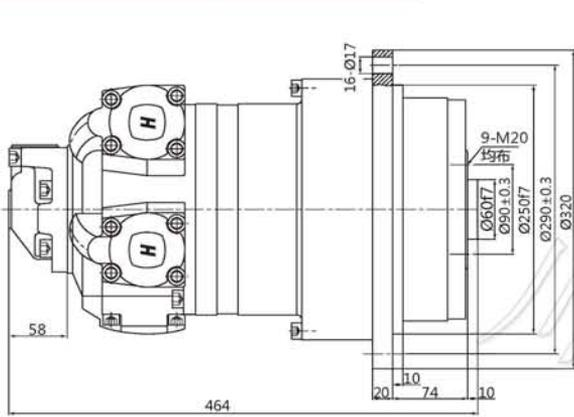

液压原理图  
Hydraulic schematic diagram

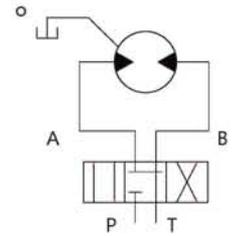

### ◆带制动器 (外置式) / With brake and external installation

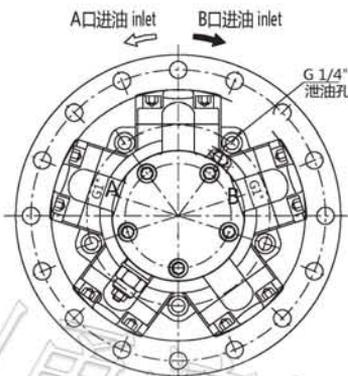
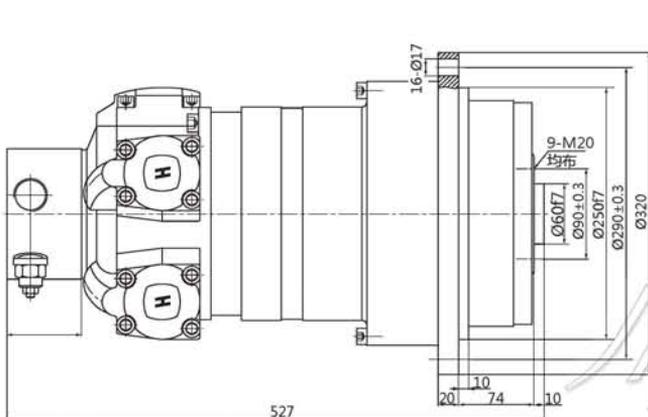

液压原理图  
Hydraulic schematic diagram

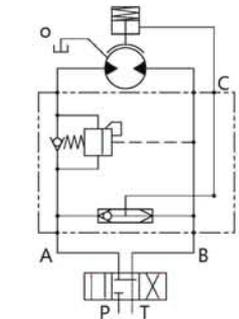

### ◆输出轴尺寸 / Shaft dimensions

B型平键输出 Cylindrical B

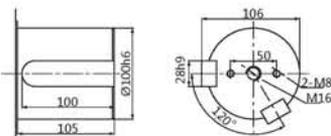

C型螺纹法兰输出 Threaded flange C

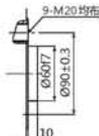

F型矩形花键输出 Rectangle splined F

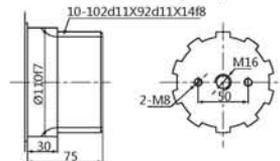

I型内花键输出 Rectangle internal spline I

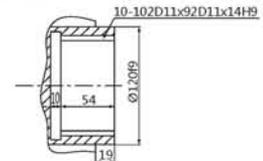

型号 Model	总排量 (ml/r) Total displacement	额定扭矩 (N.m) Rated torque		转速范围 Speed	总效率 Total efficiency	液压马达型号 Hydraulic motor	行星减速器型号 Poanetary gearbox	制动器型号 Brake
		16MPa	20MPa					
CFX2.53-2250	2260	5068	6336	0-18	0.88-0.9	CHM2-100	C2.53-20	CZ2.5
CFX2.53-2550	2543	5701	7126	0-18	0.88-0.9	CHM2-100	C2.53-22.5	CZ2.5
CFX2.53-3200	3180	7040	8800	0-18	0.88-0.9	CHM2-150	C2.53-20	CZ2.5
CFX2.53-3600	3600	7884		0-18	0.88-0.9	CHM2-175	C2.53-20	CZ2.5
CFX2.53-4100	4120	9011		0-18	0.88-0.9	CHM2-200	C2.53-20	CZ2.5

注：外形联结尺寸及输出轴有特殊要求，请与我们联系 / Note: Please contact us if there are any requirements from customer

# CFX系列液压传动/回转装置

## CFX34 液压传动装置 CFX34 Hydraulic Transmission Devices

### ◆无制动器 / Without brake

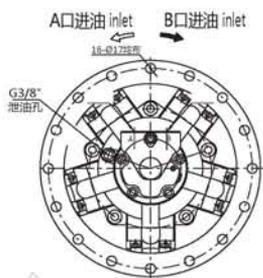
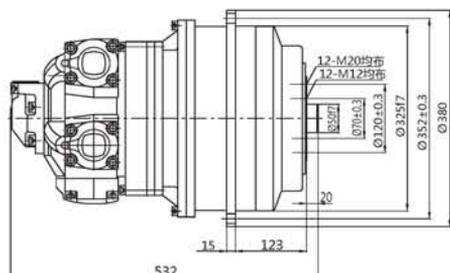

液压原理图  
Hydraulic schematic diagram

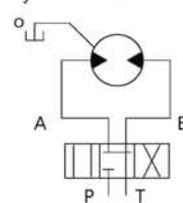

### ◆带制动器 (外置式) / With brake and external installtion

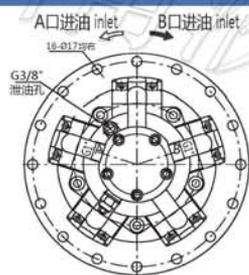
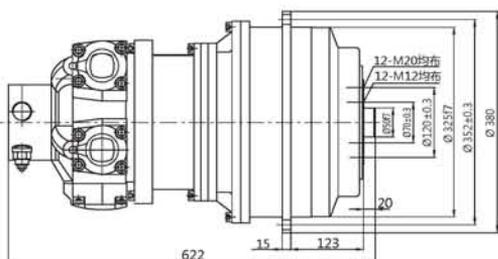

液压原理图  
Hydraulic schematic diagram

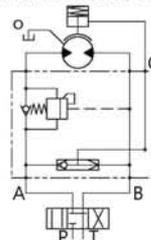

### ◆带制动器 (内置式) / With brake and internal installtion

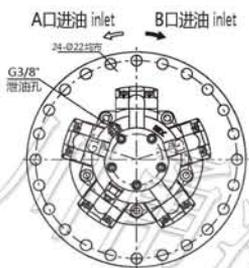
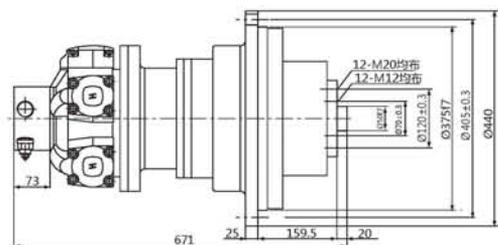

液压原理图  
Hydraulic schematic diagram

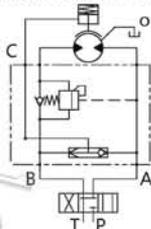

### ◆输出轴尺寸 / Shaft dimensions

B型平键输出 Cylindrical B

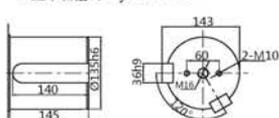

C型螺纹法兰输出 Threaded flange C

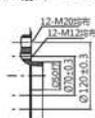

F型矩形花键输出 Rectangle splined F

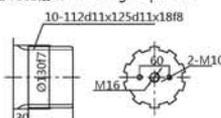

I型内花键输出 Rectangle internal spline I

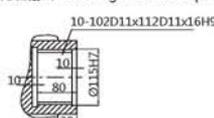

型号 Model	总排量 (ml/r) Total displacement	额定扭矩 (N.m) Rated torque		转速范围 Speed	总效率 Total efficiency	液压马达型号 Hydraulic motor	行星减速器型号 Poanetary gearbox	制动器型号 Brake
		16MPa	20MPa					
CFX34-3600	3620	7885	9856	0-16	0.88-0.9	CHM3-175	C34-20	CZ3
CFX34-4000	4020	9011	11264	0-16	0.88-0.9	CHM3-200	C34-20	CZ3
CFX34-5000	5068	11039	13798	0-15	0.88-0.9	CHM3-175	C34-28	CZ3
CFX34-5600	5628	12615	15769	0-15	0.88-0.9	CHM3-200	C34-28	CZ3
CFX34-7100	7112	15769		0-15	0.88-0.9	CHM3-250	C34-28	CZ3
CFX34-8100	8092	18135		0-15	0.88-0.9	CHM3-300	C34-28	CZ3

注：外形联结尺寸及输出轴有特殊要求，请与我们联系 / Note: Please contact us if there are any requirements from customer

# CFX系列液压传动/回转装置

## CFX45 液压传动装置 CFX45 Hydraulic Transmission Devices

### ◆无制动器 / Without brake

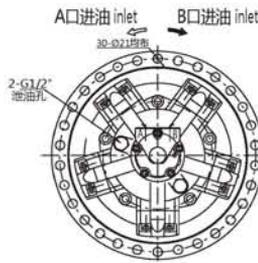
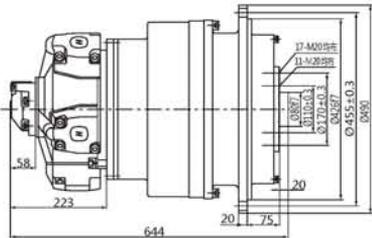

液压原理图  
Hydraulic schematic diagram

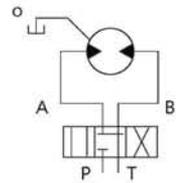

### ◆带制动器 (外置式) / With brake and external installation

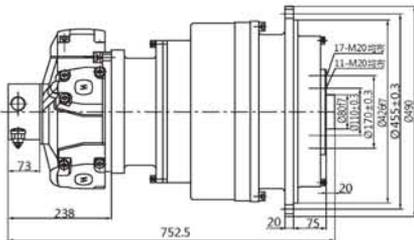

液压原理图  
Hydraulic schematic diagram

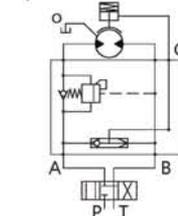

### ◆带制动器 (内置式) / With brake and internal installation

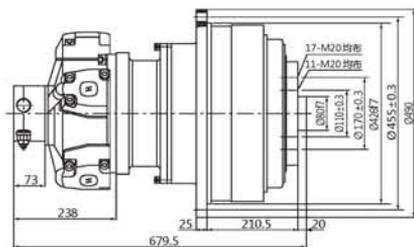

液压原理图  
Hydraulic schematic diagram

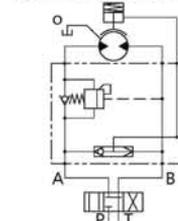

### ◆输出轴尺寸 / Shaft dimensions

B型平键输出 Cylindrical B

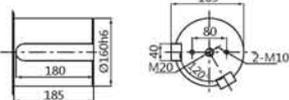

C型螺纹法兰输出 Threaded flange C



F型矩形花键输出 Rectangle splined F

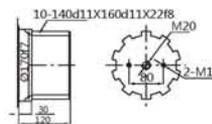

I型内花键输出 Rectangle internal spline I

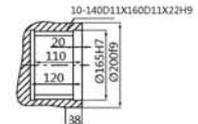

型号 Model	总排量 (ml/r) Total displacement	额定扭矩 (N.m) Rated torque		转速范围 Speed	总效率 Total efficiency	液压马达型号 Hydraulic motor	行星减速器型号 Poanetary gearbox	制动器型号 Brake
		16MPa	20MPa					
CFX45-8000	7940	16704	20880	0-15	0.88-0.9	CHM6-400	C45-20	CZ4
CFX45-9000	9040	18450	23063	0-15	0.88-0.9	CHM6-450	C45-20	CZ4
CFX45-10000	9820	20599	25748	0-15	0.88-0.9	CHM6-500	C45-20	CZ4
CFX45-11000	11116	23386	29232	0-11	0.88-0.9	CHM6-400	C45-28	CZ4
CFX45-12500	12656	25830	32288	0-11	0.88-0.9	CHM6-450	C45-28	CZ4
CFX45-14000	13748	28838		0-11	0.88-0.9	CHM6-500	C45-28	CZ4

注：外形联结尺寸及输出轴有特殊要求，请与我们联系 / Note: Please contact us if there are any requirements from customer

# CFX系列液压传动/回转装置

## CFX56 液压传动装置 CFX56 Hydraulic Transmission Devices

### ◆无制动器 / Without brake

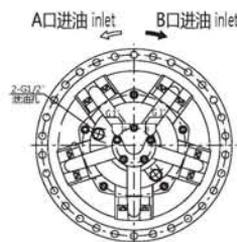
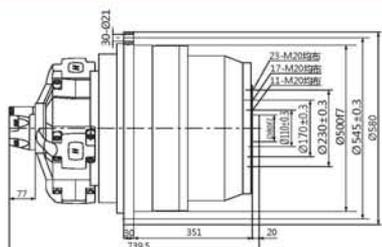

液压原理图  
Hydraulic schematic diagram

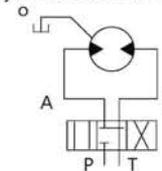

### ◆带制动器 (外置式) / With brake and external installation

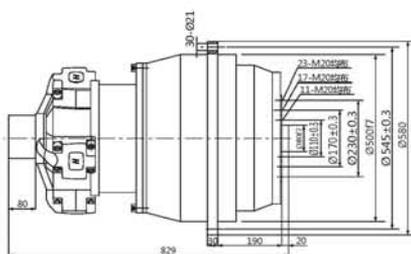

液压原理图  
Hydraulic schematic diagram

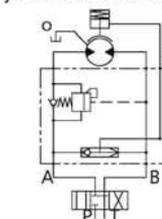

### ◆带制动器 (内置式) / With brake and internal installation

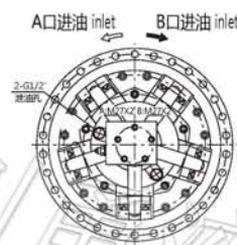
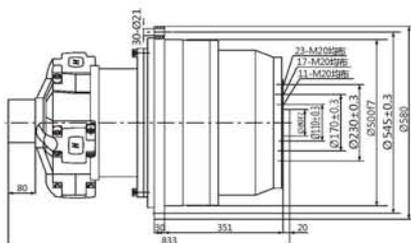

液压原理图  
Hydraulic schematic diagram

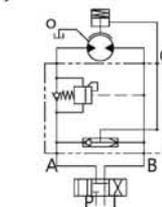

### ◆输出轴尺寸 / Shaft dimensions

B型平键输出 Cylindrical B

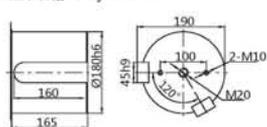

C型螺纹法兰输出 Threaded flange C

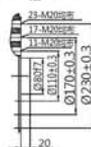

F型矩形花键输出 Rectangle spined F

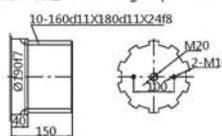

型内花键输出 Rectangle internal spline I

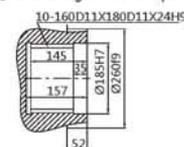

型号 Model	总排量 (ml/r) Total displacement	额定扭矩 (N.m) Rated torque		转速范围 Speed	总效率 Total efficiency	液压马达型号 Hydraulic motor	行星减速器型号 Poanetary gearbox	制动器型号 Brake
		16MPa	20MPa					
CFX56-14000	13640	30041	37551	0-14	0.88-0.9	CHM11-700	C56-20	CZ5
CFX56-16000	15640	33330	41662	0-14	0.88-0.9	CHM11-800	C56-20	CZ5
CFX56-18000	17880	39198	48998	0-14	0.88-0.9	CHM11-900	C56-20	CZ5
CFX56-19000	19124	42057	52571	0-10	0.88-0.9	CHM11-700	C56-28	CZ5
CFX56-22000	21896	46662	58327	0-10	0.88-0.9	CHM11-800	C56-28	CZ5
CFX56-25000	25032	54878		0-10	0.88-0.9	CHM11-900	C56-28	CZ5
CFX56-28000	27468	58091		0-10	0.88-0.9	CHM11-1000	C56-28	CZ5

注：外形联结尺寸及输出轴有特殊要求，请与我们联系 / Note: Please contact us if there are any requirements from customer

# CFX系列液压传动/回转装置

## CFX67 液压传动装置 CFX67 Hydraulic Transmission Devices

### ◆无制动器 / Without brake

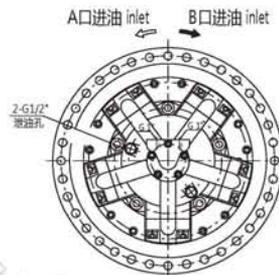
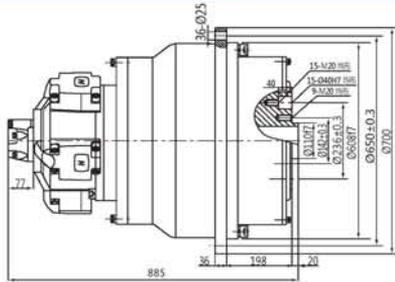

液压原理图  
Hydraulic schematic diagram

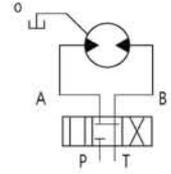

### ◆带制动器 (外置式) / With brake and external installation

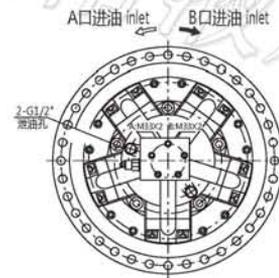
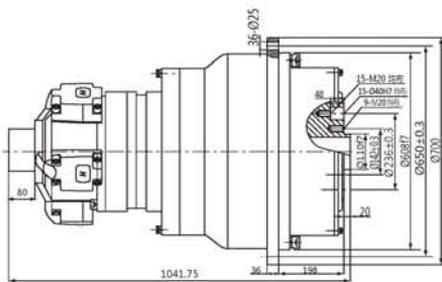

液压原理图  
Hydraulic schematic diagram

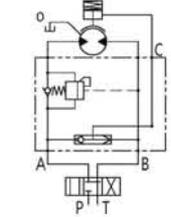

### ◆带制动器 (内置式) / With brake and internal installation

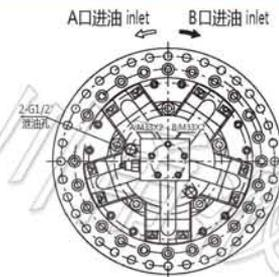
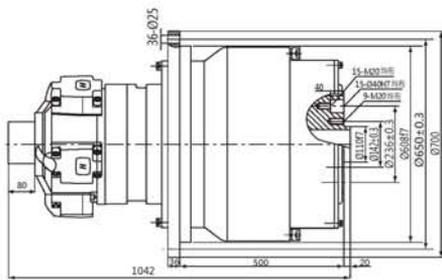

液压原理图  
Hydraulic schematic diagram

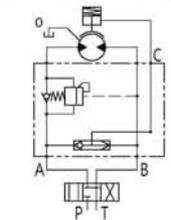

### ◆输出轴尺寸 / Shaft dimensions

B型平键输出 Cylindrical B

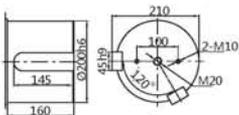

C型螺纹法兰输出 Threaded flange C

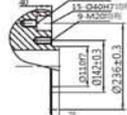

F型矩形花键输出 Rectangle splined F

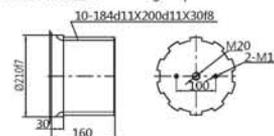

I型内花键输出 Rectangle internal spline I

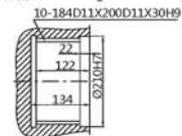

型号 Model	总排量 (ml/r) Total displacement	额定扭矩 (N.m) Rated torque		转速范围 Speed	总效率 Total efficiency	液压马达型号 Hydraulic motor	行星减速器型号 Poanetary gearbox	制动器型号 Brake
		16MPa	20MPa					
CFX67-28000	28260	57874	72342	0-8	0.88-0.9	CHM16-1400	C67-20	CZ6
CFX67-33000	32960	69364	86704	0-8	0.88-0.9	CHM16-1600	C67-20	CZ6
CFX67-36000	36280	76497	95621	0-8	0.88-0.9	CHM16-1800	C67-20	CZ6
CFX67-40000	39564	81024	101280	0-6	0.88-0.9	CHM16-1400	C67-28	CZ6
CFX67-46000	46144	97109		0-6	0.88-0.9	CHM16-1600	C67-28	CZ6

注：外形联结尺寸及输出轴有特殊要求，请与我们联系 / Note: Please contact us if there are any requirements from customer

# CFX系列液压传动/回转装置

## CFX79 液压传动装置 CFX79 Hydraulic Transmission Devices

### ◆无制动器 / Without brake

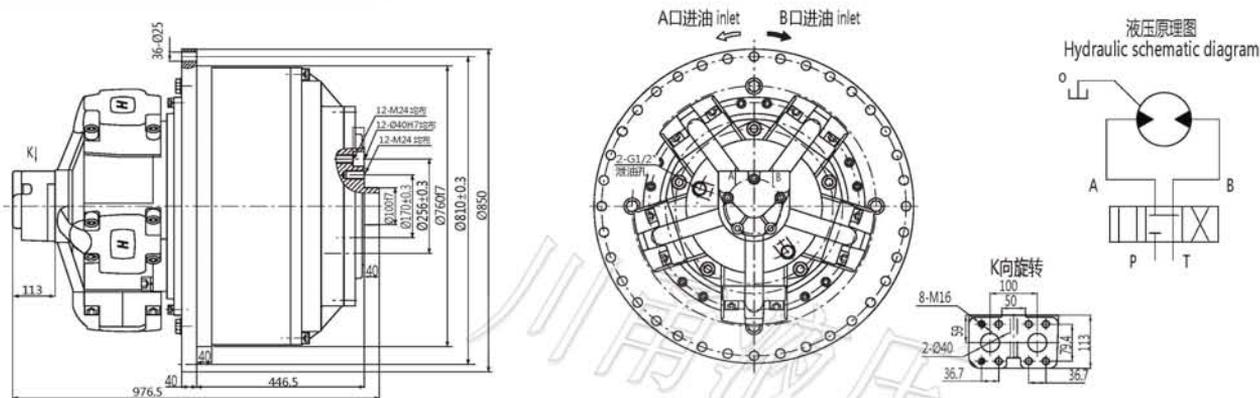

### ◆带制动器 (外置式) / With brake and external installation

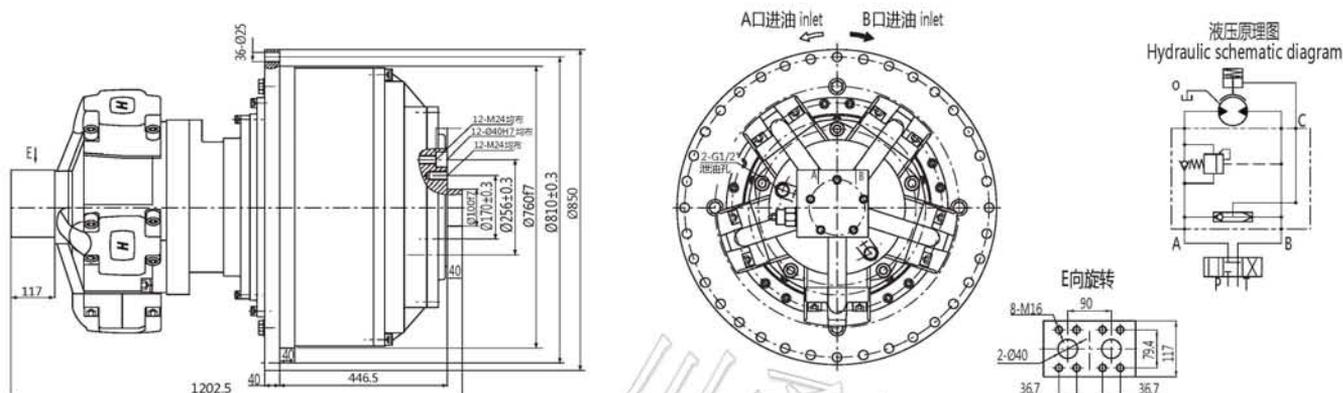

### ◆输出轴尺寸 / Shaft dimensions

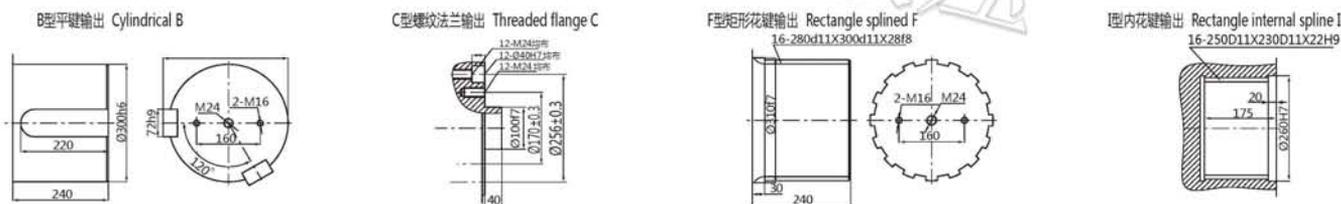

型号 Model	总排量 (ml/r) Total displacement	额定扭矩 (N.m) Rated torque		转速范围 Speed	总效率 Total efficiency	液压马达型号 Hydraulic motor	行星减速器型号 Poanetary gearbox	制动器型号 Brake
		16MPa	20MPa					
CFX79-4 1000	40848	85813	107267	0-9	0.88-0.9	CHM31-2500	C79-16	CZ7
CFX79-43 000	42928	95149	118936	0-9	0.88-0.9	CHM31-2800	C79-16	CZ7
CFX79-5 0000	51060	107267	134083	0-7	0.88-0.9	CHM31-2500	C79-20	CZ7
CFX79-54 000	53660	118936	148670	0-7	0.88-0.9	CHM31-2800	C79-20	CZ7
CFX79-64 000	64360	132239	165229	0-7	0.88-0.9	CHM31-3150	C79-20	CZ7
CFX79-69 000	69240	143898	179872	0-6	0.88-0.9	CHM31-3500	C79-20	CZ7
CFX79-83 000	83040	175732		0-6	0.88-0.9	CHM31-4000	C79-20	CZ7

注：外形联结尺寸及输出轴有特殊要求，请与我们联系 / Note: Please contact us if there are any requirements from customer

# CFX系列液压传动/回转装置

## CFX912 液压传动装置 CFX912 Hydraulic Transmission Devices

### ◆无制动器 / Without brake

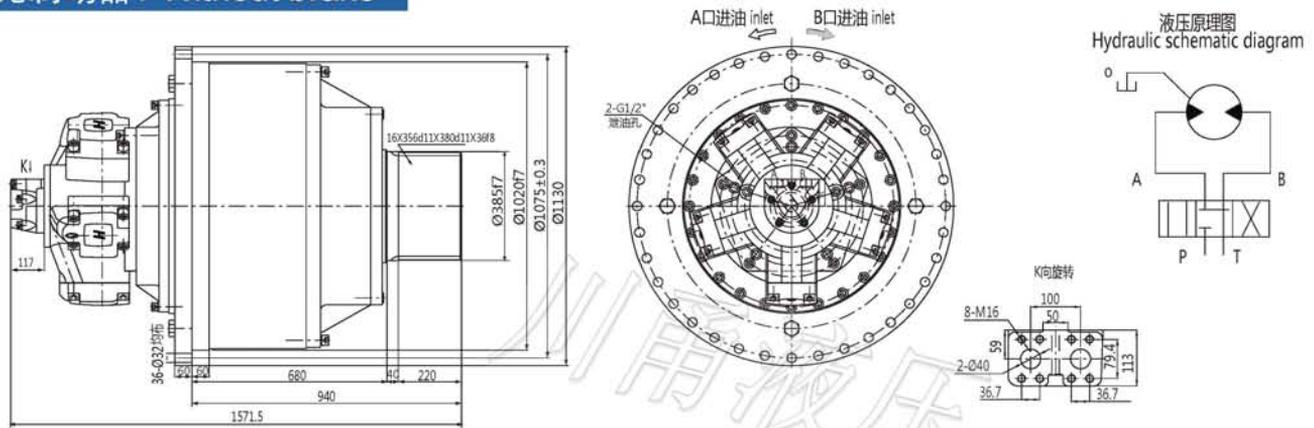

### ◆带制动器 (外置式) / With brake and external installation

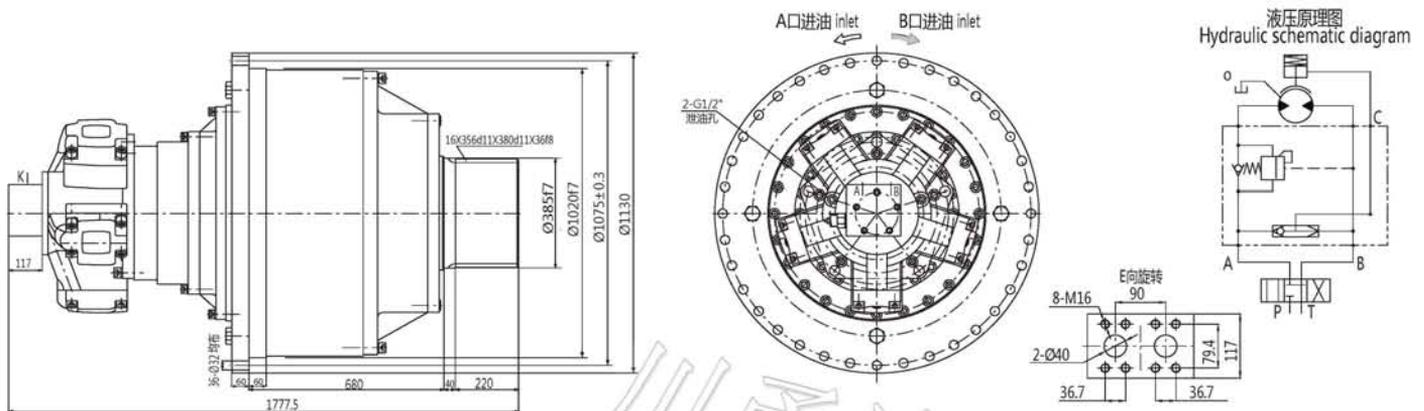

### ◆输出轴尺寸 / Shaft dimensions

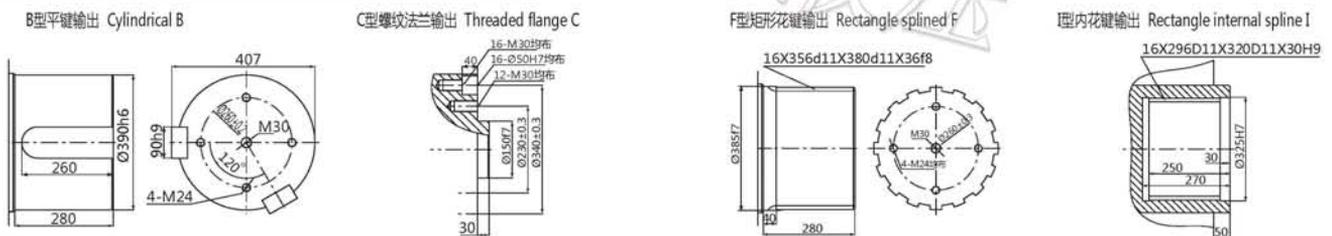

型号 Model	总排量 (ml/r) Total displacement	额定扭矩 (N.m) Rated torque		转速范围 Speed	总效率 Total efficiency	液压马达型号 Hydraulic motor	行星减速器型号 Poanetary gearbox	制动器型号 Brake
		16MPa	20MPa					
CFX912-100000	96936	200000	250000	0-4	0.88-0.9	CHM40-3500	C912-28	CZ9
CFX912-115000	116340	248800	310000	0-4	0.88-0.9	CHM40-4000	C912-28	CZ9
CFX912-125000	126672	270000	340000	0-4	0.88-0.9	CHM40-4500	C912-28	CZ9
CFX912-140000	139664	320000		0-3.5	0.88-0.9	CHM40-5000	C912-28	CZ9
CFX912-155000	154224	350000		0-3.3	0.88-0.9	CHM40-5500	C912-28	CZ9
CFX912-175000	176708	384000		0-3.2	0.88-0.9	CHM40-6300	C912-28	CZ9

注：外形联结尺寸及输出轴有特殊要求，请与我们联系 / Note: Please contact us if there are any requirements from customer

## ◆ 安装说明

1. 因为行星减速机的安装多样性,用户选型时,需要确定其安装位置,常见的有水平,垂直向下,竖直朝上三种形式,根据安装位置的不同,在设计减速机时就考虑到内部运动机构支撑,而进出油口、通气孔、放油塞等位置都会有区别。水平安装时,润滑油必须加到减速机轴线的一半,而其余两种情况必须将润滑油加满,并将最高处的透气塞拧松一个,令空气排走。

2. 减速机安装到设备上时必须使用起吊设备,将减速机小心地固定于吊钩上,起吊过程注意防止起吊附件将减速机的防尘圈或者螺纹被破坏。

3. 确认安装前主机机座上的安装孔无异物,机座加工尺寸符合设计要求,并在减速机的安装止口上涂抹一层薄薄的黄油。保证安装时无卡滞,不同轴现象。头次运转前不要把螺丝完全上紧,运行一小段时间后再拧紧安装螺丝。这样可以起自动定心作用。

## ◆ 维护和保养说明

当减速机日常运行时,任何旋转部分都是有对人体伤害的可能,都不允许接触。对机械部件的日常维护可以大大提高减速机的使用寿命。

1. 每日例行检查减速机或者马达是否有漏油或者发热等异常状况。
2. 定期检查液压马达是否有泄漏过大等现象。
3. 定期检查各部件是否有异常噪音。
4. 定期检查油位(油标,油位螺塞)。
5. 定期按照保养规程更换润滑油。
6. 至少每月检查所有连接螺钉和螺栓的紧固性。

## ◆ 制动器无需保养

制动器如果出现故障,摩擦片、弹簧、和密封件都属于易损件,需要在维修时才能更换

附录:随机附带易损件:O型圈 摩擦片等。随机资料:使用说明书,合格证等

**!** 特殊附件应在合同中注明!

## ◆ 运输和贮存

应该把减速机当作易碎品来运输,上货和卸货过程必须采用经批准的装卸装置,装卸转运过程中应确信不会引起减速机本身的损坏,接货时应检查所提供设备的完整性,检查是否与合同约定货物相符合,如有任何差错或者运输损坏,请立即与本公司联系,并要求该事宜采用书面形式。

减速机只能存放在干燥常温的房间,当贮存期超过12个月时,必须进行相应的防锈处理,应在法兰表面轴端均匀地涂上一层防锈油,外表面再用防锈膜覆盖。并作定期检查。

### CHW液压绞车（内置CFH液压传动装置）



### CXW液压绞车（内置CFX液压传动装置）



宁波川甬液压公司拥有多年从事液压技术和相关主机研究的资深科技人员，能帮助您设计全套液压传动装置，选用最合适的液压传动件，并给您提供包括主机在内的各种技术建议。

# 请向我们咨询



川甬液压

川甬液压

诚信 优质 合作 共赢

川甬液压

宁波川甬液压传动设备有限公司

NINGBO CHUANYONG

Hydraulic Transmission Equipment Co., Ltd.

地址：中国浙江省宁波市北仑区柴桥工业区55号

邮编：315800

TEL：0574-56583889

18268586917

FAX：0574-56583889

E-mail：nb18268586917@126.com

Http://www.nbcyyy.com

川甬液压